



ESAB ET 220i AC/DC



Art # A-12839_AB

Operating Manual

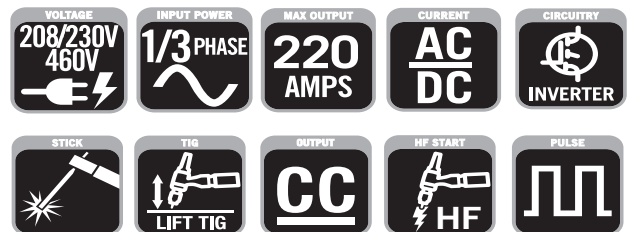

Révision : AD	Issue Date: October 26, 2016	Manual No.: 0-5346
---------------	------------------------------	--------------------

esab.com



WE APPRECIATE YOUR BUSINESS!

Congratulations on your new ESAB product. We are proud to have you as our customer and will strive to provide you with the best service and reliability in the industry. This product is backed by our extensive warranty and world-wide service network. To locate your nearest distributor or service agency, visit us on the web at www.esab.com

This Operating Manual has been designed to instruct you on the correct use and operation of your ESAB product. Your satisfaction with this product and its safe operation is our ultimate concern. Therefore please take the time to read the entire manual, especially the Safety Precautions. They will help you to avoid potential hazards that may exist when working with this product.

YOU ARE IN GOOD COMPANY!

The Brand of Choice for Contractors and Fabricators Worldwide.

ESAB is a Global Brand of Welding Products.

We distinguish ourselves from our competition through market-leading, dependable products that have stood the test of time. We pride ourselves on technical innovation, competitive prices, excellent delivery, superior customer service and technical support, together with excellence in sales and marketing expertise.

Above all, we are committed to developing technologically advanced products to achieve a safer working environment within the welding industry.



WARNING

Read and understand this entire Manual and your employer's safety practices before installing, operating, or servicing the equipment.

While the information contained in this Manual represents the Manufacturer's best judgement, the Manufacturer assumes no liability for its use.

Welding Power Supply
Operating Manual Number 0-5346 for:

ESAB ET 220i AC/DC Power Source Part Number W1009300

Published by:
ESAB
2800 Airport Rd.
Denton, Texas 76207

www.esab.com

Copyright © 2015 by
ESAB

All rights reserved.

Reproduction of this work, in whole or in part, without written permission of the publisher is prohibited.

The publisher does not assume and hereby disclaims any liability to any party for any loss or damage caused by any error or omission in this Manual, whether such error results from negligence, accident, or any other cause.

Publication Date: May 7, 2015
Revision Date: October 26, 2016

Record the following information for Warranty purposes:

Where Purchased: _____

Purchase Date: _____

Equipment Serial #: _____

**Be sure this information reaches the operator.
You can get extra copies through your supplier.**

CAUTION

These INSTRUCTIONS are for experienced operators. If you are not fully familiar with the principles of operation and safe practices for arc welding and cutting equipment, we urge you to read our booklet, "Precautions and Safe Practices for Arc Welding, Cutting, and Gouging," Form 0-5407. Do NOT permit untrained persons to install, operate, or maintain this equipment. Do NOT attempt to install or operate this equipment until you have read and fully understand these instructions. If you do not fully understand these instructions, contact your supplier for further information. Be sure to read the Safety Precautions before installing or operating this equipment.

USER RESPONSIBILITY

This equipment will perform in conformity with the description thereof contained in this manual and accompanying labels and/or inserts when installed, operated, maintained and repaired in accordance with the instructions provided. This equipment must be checked periodically. Malfunctioning or poorly maintained equipment should not be used. Parts that are broken, missing, worn, distorted or contaminated should be replaced immediately. Should such repair or replacement become necessary, the manufacturer recommends that a telephone or written request for service advice be made to the Authorized Distributor from whom it was purchased.

This equipment or any of its parts should not be altered without the prior written approval of the manufacturer. The user of this equipment shall have the sole responsibility for any malfunction which results from improper use, faulty maintenance, damage, improper repair or alteration by anyone other than the manufacturer or a service facility designated by the manufacturer.

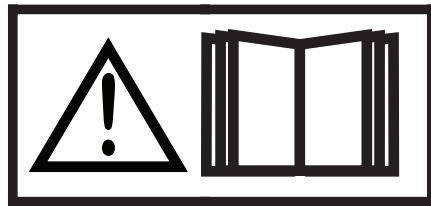

**READ AND UNDERSTAND THE INSTRUCTION MANUAL BEFORE INSTALLING OR
OPERATING.**

PROTECT YOURSELF AND OTHERS!

TABLE OF CONTENTS

SECTION 1: SAFETY	1-1
1.0 Safety Precautions.....	1-1
SECTION 2:	
INTRODUCTION	2-1
2.01 How To Use This Manual	2-1
2.02 Equipment Identification	2-1
2.03 Receipt of Equipment.....	2-1
2.04 Description	2-1
2.05 User Responsibility	2-1
2.06 Transporting Methods.....	2-2
2.07 Packaged Items	2-2
2.08 Duty Cycle.....	2-2
2.09 Specifications	2-3
2.10 Optional Accessories	2-4
SECTION 3:	
INSTALLATION, OPERATION AND SETUP	3-1
3.01 Environment	3-1
3.02 Location.....	3-1
3.03 Ventilation.....	3-1
3.04 Mains Supply Voltage Requirements	3-1
3.05 High Frequency Introduction	3-2
3.06 High Frequency Interference	3-2
3.07 Electromagnetic Compatibility	3-3
3.08 Power Source Controls, Indicators and Features	3-4
3.09 Setup for TIG (GTAW) Welding	3-10
3.10 TIG (GTAW) Programming Mode	3-13
3.11 TIG (GTAW) Welding Secondary Parameters	3-18
3.12 GTAW Spot Welding Mode with DWELL Time (Stitch Mode).....	3-19
3.13 Tip Tronic Operation.....	3-20
3.14 Setup for Stick (SMAW) Welding	3-22
3.15 Stick (SMAW) Programming Mode.....	3-23
3.16 User Specific Menus	3-26
3.17 Special Function	3-27
3.18 Shielding Gas Regulator/ Flowmeter Operating Instructions.....	3-30
3.19 Foot Control, Part No. W4013200 (Optional Accessory)	3-32
SECTION 4:	
BASIC WELDING GUIDE	4-1
4.01 Stick (SMAW) Basic Welding Technique	4-1
4.02 Stick (SMAW) Welding Troubleshooting.....	4-8
4.03 TIG (GTAW) Basic Welding Technique	4-11
4.04 TIG (GTAW) Welding Problems.....	4-13

TABLE OF CONTENTS

SECTION 5:
POWER SOURCE PROBLEMS AND ROUTINE SERVICE REQUIREMENTS 5-1

- 5.01 Basic Troubleshooting 5-1
- 5.02 Power Source Problems 5-3
- 5.03 Routine Service and Calibration Requirements 5-4
- 5.04 Cleaning the Welding Power Source 5-5

SECTION 6:
KEY SPARE PARTS 6-1

- 6.01 Key Spare Parts 6-2

APPENDIX A: CIRCUIT DIAGRAM OF ET 220i AC/DC A-1

REVISION HISTORY A-2

SECTION 1: SAFETY

1.0 Safety Precautions

Users of ESAB welding and plasma cutting equipment have the ultimate responsibility for ensuring that anyone who works on or near the equipment observes all the relevant safety precautions. Safety precautions must meet the requirements that apply to this type of welding or plasma cutting equipment. The following recommendations should be observed in addition to the standard regulations that apply to the workplace.

All work must be carried out by trained personnel well acquainted with the operation of the welding or plasma cutting equipment. Incorrect operation of the equipment may lead to hazardous situations which can result in injury to the operator and damage to the equipment.

1. Anyone who uses welding or plasma cutting equipment must be familiar with:
 - its operation
 - location of emergency stops
 - its function
 - *relevant safety precautions*
 - welding and / or plasma cutting
2. The operator must ensure that:
 - no unauthorized person stationed within the working area of the equipment when it is started up.
 - no one is unprotected when the arc is struck.
3. The workplace must:
 - be suitable for the purpose
 - be free from drafts
4. Personal safety equipment:
 - Always wear recommended personal safety equipment, such as safety glasses, flame proof clothing, safety gloves.
 - Do not wear loose fitting items, such as scarves, bracelets, rings, etc., which could become trapped or cause burns.
5. General precautions:
 - Make sure the return cable is connected securely.
 - Work on high voltage equipment **may only be carried out by a qualified electrician.**
 - Appropriate fire extinguishing equipment must be clearly marked and close at hand.
 - Lubrication and maintenance **must not** be carried out on the equipment during operation.



Dispose of electronic equipment at the recycling facility!

In observance of European Directive 2002/96/EC on Waste Electrical and Electronic Equipment and its implementation in accordance with national law, electrical and/or electronic equipment that has reached the end of its life must be disposed of at a recycling facility.

As the person responsible for the equipment, it is your responsibility to obtain information on approved collection stations. For further information contact the nearest ESAB dealer.

ESAB can provide you with all necessary welding protection and accessories.

WARNING

Arc welding and cutting can be injurious to yourself and others. Take precautions when welding and cutting. Ask for your employer's safety practices which should be based on manufacturers' hazard data.

ELECTRIC SHOCK - Can kill.

- Install and earth (ground) the welding or plasma cutting unit in accordance with applicable standards.
- Do not touch live electrical parts or electrodes with bare skin, wet gloves or wet clothing.
- Insulate yourself from earth and the workpiece.
- Ensure your working stance is safe.

FUMES AND GASES - Can be dangerous to health.

- Keep your head out of the fumes.
- Use ventilation, extraction at the arc, or both, to take fumes and gases away from your breathing zone and the general area.

ARC RAYS - Can injure eyes and burn skin.

- Protect your eyes and body. Use the correct welding / plasma cutting screen and filter lens and wear protective clothing.
- Protect bystanders with suitable screens or curtains.

FIRE HAZARD

- Sparks (spatter) can cause fire. Make sure therefore that there are no inflammable materials nearby.

NOISE - Excessive noise can damage hearing.

- Protect your ears. Use earmuffs or other hearing protection.
- Warn bystanders of the risk.

MALFUNCTION - Call for expert assistance in the event of malfunction.

READ AND UNDERSTAND THE INSTRUCTION MANUAL BEFORE INSTALLING OR OPERATING.

PROTECT YOURSELF AND OTHERS!

WARNING

Do not use the power source for thawing frozen pipes.

CAUTION

Class A equipment is not intended for use in residential locations where the electrical power is provided by the public low-voltage supply system. There may be potential difficulties in ensuring electromagnetic compatibility of class A equipment in those locations, due to conducted as well as radiated disturbances.

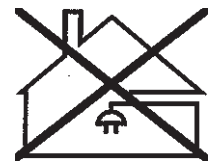

CAUTION

This product is solely intended for welding. Any other use may result in personal injury and / or equipment damage.

CAUTION

Read and understand the instruction manual before installing or operating.



SECTION 2: INTRODUCTION

2.01 How To Use This Manual

To ensure safe operation, read the entire manual, including the chapter on safety instructions and warnings. Throughout this manual, the words WARNING, CAUTION, and NOTE may appear. Pay particular attention to the information provided under these headings. These special annotations are easily recognized as follows:



NOTE!

An operation, procedure, or background information which requires additional emphasis or is helpful in efficient operation of the system.



CAUTION

A procedure which, if not properly followed, may cause damage to the equipment.



WARNING

A procedure which, if not properly followed, may cause injury to the operator or others in the operating area.



WARNING

Gives information regarding possible electrical shock injury. Warnings will be enclosed in a box such as this.

You will also notice other icons appearing throughout the manual. These are to advise you of specific types of hazards or cautions related to the portion of information that follows. Some may have multiple hazards that apply and would look something like this:



2.02 Equipment Identification

The unit's identification number (specification or part number), model, and serial number usually appear on a nameplate attached to the control panel. In some cases, the nameplate may be attached to the rear panel. Equipment which does not have a control panel such as gun and cable assemblies is identified only by the specification or part number printed on the shipping container. Record these numbers on the bottom of page ii for future reference.

2.03 Receipt of Equipment

When you receive the equipment, check it against the invoice to make sure it is complete and inspect the equipment for possible damage due to shipping. If there is any damage, notify the carrier immediately to file a claim. Furnish complete information concerning damage claims or shipping errors to the location in your area listed in the inside back cover of this manual.

Include all equipment identification numbers as described above along with a full description of the parts in error.

Move the equipment to the installation site before un-crating the unit. Use care to avoid damaging the equipment when using bars, hammers, etc., to un-crate the unit.

2.04 Description

The ET 220i AC/DC is light weight constant current welding power sources incorporating the latest digital inverter technology to provide exceptional AC/DC arc characteristics, TIG welding features include torch trigger latch, pre & post flow gas control, pulse control, spot weld control, hot start control, up & down slope control. Liftarc TIG and HF TIG operating modes are available.

This unit also has outstanding arc characteristics across a wide range of Manual Metal Arc Welding (SMAW) electrodes. SMAW welding features, hot start control and arc force control. The units are equipped with digital amperage and voltage meters. The unit are also fully compliant to European Standard EN 60974-1 and IEC 60974.1.

The ET 220i AC/DC provide excellent welding performance across a broad range of applications when used with the correct welding consumables and procedures. The following instructions detail how to correctly and safely set up the machine and give guidelines on gaining the best efficiency and quality from the Power Source. Please read these instructions thoroughly before using the unit.

2.05 User Responsibility

This equipment will perform as per the information contained herein when installed, operated, maintained and repaired in accordance with the instructions provided. This equipment must be checked periodically. Defective equipment (including welding leads) should not be used. Parts that are broken, missing, plainly worn, distorted or contaminated, should be replaced immediately. Should such repairs or replacements become necessary, it is recommended that such repairs be carried out by appropriately qualified persons approved by ESAB. Advice in this regard can be obtained by contacting an Accredited ESAB Distributor.

This equipment or any of its parts should not be altered from standard specification without prior written approval of ESAB. The user of this equipment shall have the sole responsibility for any malfunction which results from improper use or unauthorized modification from standard specification, faulty maintenance, damage or improper repair by anyone other than appropriately qualified persons approved by ESAB.

ET 220i AC/DC

2.06 Transporting Methods



WARNING

Disconnect input power conductors from de-energized supply line before moving the welding Power Source.

Lift Power Source with handle on top of case. Use handcart or similar device of adequate capacity. If using a fork lift vehicle, secure the Power Source on a proper skid before transporting.

2.07 Packaged Items

ET 220i AC/DC Inverter Power Source (Part No. W1009300)

- ET 220i AC/DC Inverter Power Source
- Two male 50mm Dinse connectors
- Operating Manual

2.08 Duty Cycle

The rated duty cycle of a Welding Power Source, is a statement of the time it may be operated at its rated welding current output without exceeding the temperature limits of the insulation of the component parts. To explain the 10 minute duty cycle period the following example is used. Suppose a Welding Power Source is designed to operate at a 40% duty cycle, 170 amperes at 26.8 volts. This means that it has been designed and built to provide the rated amperage (170A) for 4 minutes, i.e. arc welding time, out of every 10 minute period (40% of 10 minutes is 4 minutes). During the other 6 minutes of the 10 minute period the Welding Power Source must be idle and be allowed to cool. The thermal cut out will operate if the duty cycle is exceeded.

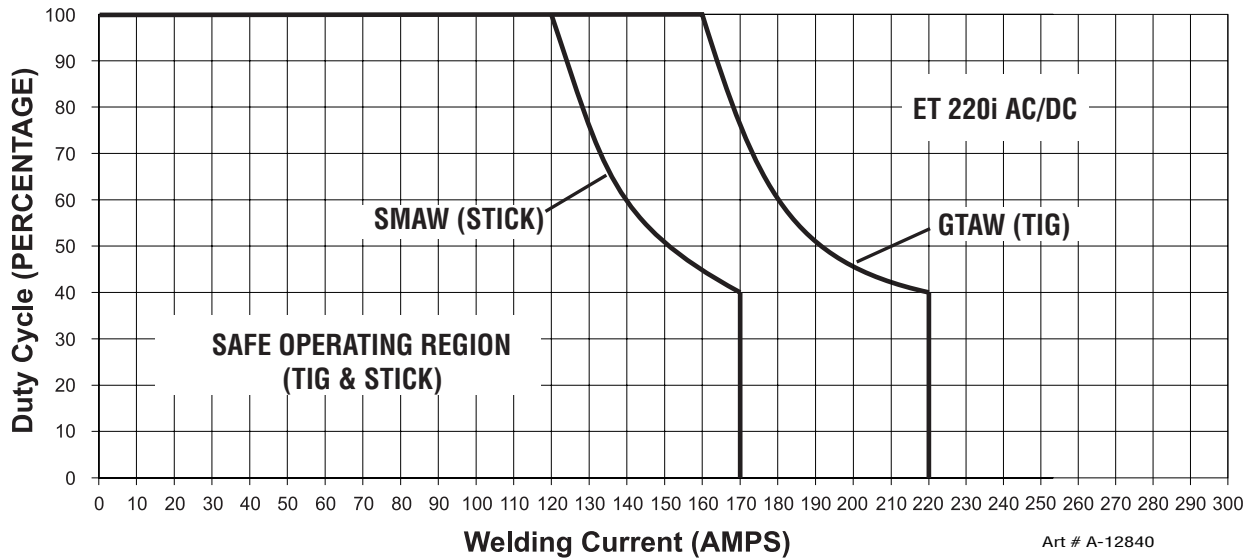

Figure 2-1: ET 220i AC/DC Duty Cycle

2.09 Specifications

Description	ET 220i AC/DC	
Power Source Part Number	W1009300	
Power Source Mass	29.5lbs (13.4Kg) without power cable	
Power Source Dimensions	H13" x W7.25" x D19" (H326mm x W185mm x D483mm)	
Cooling	Fan Cooled	
Welder Type	Inverter Power Source	
Standards	CSA E60974-1, ANSI/IEC 60974-1	
Number of Phases	1/3 phase	
Nominal Supply Voltage	208-230/460VAC (1 phase) +/-15%	208-230/460VAC (3 phase) +/-15%
Nominal Supply Frequency	50/60Hz	
Welding Current Range (Stick Mode)	10 – 150A (1 phase)	10 – 170A (3 phase)
Welding Current Range (TIG Mode)	5 - 200A (1 phase)	5 - 220A (3 phase)
Effective Input Current ($I_{1\text{eff}}$) (note2)	27.6A (208V, 1 phase) 25.0A (230V, 1 phase) 15.2A (460V, 1 phase)	16.8A (208V, 3 phase) 15.2A (230V, 3 phase) 8.2A (460V, 3 phase)
Maximum Input Current ($I_{1\text{max}}$)	37.3A (208V, 1 phase) 33.7A (230V, 1 phase) 18.1A (460V, 1 phase)	24.5A (208V, 3 phase) 22.1A (230V, 3 phase) 11.9A (460V, 3 phase)
Generator Requirement (note4)	13kW (16kVA @ 0.8PF)	
Stick (SMAW) Welding Output, 40°C, 10 min.	150A @ 40%, 26.0V (1 phase) 140A @ 60%, 25.6V (1 phase) 120A @ 100%, 24.8V (1 phase)	170A @ 40%, 26.8V (3 phase) 140A @ 60%, 25.6V (3 phase) 120A @ 100%, 24.8V (3 phase)
TIG (GTAW) Welding Output, 40°C, 10 min.	200A@45%, 18.8V (1 phase) 180A@60%, 17.2V (1 phase) 160A@100%, 16.4V (1 phase)	220A @ 40%, 18.8V (3 phase) 180A @ 60%, 17.2V (3 phase) 160A @ 100%, 16.4V (3 phase)
Open Circuit Voltage (VRD active)	<113V	
Protection Class	IP23S	

Table 2-1: Power Source Specification



NOTE!

Note 1: Due to variations that can occur in manufactured products, claimed performance, voltages, ratings, all capacities, measurements, dimensions and weights quoted are approximate only. Achievable capacities and ratings in use and operation will depend upon correct installation, use, applications, maintenance and service.

Note 2: The Effective Input Current should be used for the determination of cable size & supply requirements.

Note 3: Motor start fuses or thermal circuit breakers are recommended for this application. Check local requirements for your situation in this regard.

Note 4: Generator Requirements at the Maximum Output Duty Cycle.
 Due to large variations in performance and specifications of different brands and types of generators, ESAB cannot guarantee full welding output power or duty cycle on every brand or type of generator. ESAB recommends that when selecting a generator, that the particular power source / generator combination be adequately trialed to ensure the combination performs to the users expectations.

Note 5: ESAB reserves the right to change product performance and specifications without notice.

2.10 Optional Accessories

Part Number	Description
W4014604	Tig Torch 26F with 4m lead and remote control
BGSAK2	TIG Torch accessory kit
W4013200	Foot Control with 8m lead
646757	Electrode Holder & Work Lead Set 5m 400A 50mm DINSE
646325	Electrode Holder & Work Lead Set 8m 400A 50mm DINSE
646763	Electrode Holder w / Deadman Switch & Work Lead Set 8m 400A 50mm DINSE
301526	Comet Edge Argon Regulator / Flowmeter
704461	50mm Male DINSE cable connector
W7004913	Shielding Gas Hose Assembly
W4001302	CU-6 (400V) Water Cooling Unit
W4001350	Cable Protection (CU-6)
W4010205	Cart, 2 Wheel

Table 2-2: Options and Accessories

SECTION 3: INSTALLATION, OPERATION AND SETUP

3.01 Environment

These units are designed for use in environments with increased hazard of electric shock as outlined in IEC 60974-1.

- A. Examples of environments with increased hazard of electric shock are:
1. In locations in which freedom of movement is restricted, so that the operator is forced to perform the work in a cramped (kneeling, sitting or lying) position with physical contact with conductive parts.
 2. In locations which are fully or partially limited by conductive elements, and in which there is a high risk of unavoidable or accidental contact by the operator.
 3. In wet or damp hot locations where humidity or perspiration considerable reduces the skin resistance of the human body and the insulation properties of accessories.
- B. Environments with increased hazard of electric shock do not include places where electrically conductive parts in the near vicinity of the operator, which can cause increased hazard, have been insulated.

3.02 Location

Be sure to locate the welder according to the following guidelines:

- A. In areas, free from moisture and dust.
- B. Ambient temperature between 0° C to 40° C.
- C. In areas, free from oil, steam and corrosive gases.
- D. In areas, not subjected to abnormal vibration or shock.
- E. In areas, not exposed to direct sunlight or rain.
- F. Place at a distance of 12" (300mm) or more from walls or similar that could restrict natural air flow for cooling.
- G. The enclosure design of this power source meets the requirements of IP23S as outlined in EN 60529. This provides adequate protection against solid objects (greater than 1/2", 12mm), and direct protection from vertical drops. Under no circumstances should the unit be operated or connected in a micro environment that will exceed the stated conditions. For further information please refer to EN 60529.
- H. Precautions must be taken against the power source toppling over. The power source must be located on a suitable horizontal surface in the upright position when in use.



WARNING

This equipment should be electrically connected by a qualified electrician.

3.03 Ventilation



WARNING

Since the inhalation of welding fumes can be harmful, ensure that the welding area is effectively ventilated.

3.04 Mains Supply Voltage Requirements

The Mains supply voltage should be within $\pm 15\%$ of the rated mains supply voltage. Too low a voltage may cause poor welding performance. Too high a supply voltage will cause components to overheat and possibly fail.

The Welding Power Source must be:

- Correctly installed, if necessary, by a qualified electrician.
- Correctly earthed (electrically) in accordance with local regulations.
- Connected to the correct size power point and fuse as per the Specifications on page 2-5.



WARNING

Any electrical work must be carried out by a qualified Electrical Tradesperson.



WARNING

ELECTRIC SHOCK can kill; SIGNIFICANT DC VOLTAGE is present after removal of input power.

DO NOT TOUCH live electrical parts.

SHUT DOWN welding power source, disconnect input power employing lockout/tagging procedures. Lockout/tagging procedures consist of padlocking line disconnect switch in open position, removing fuses from fuse box, or shutting off and red-tagging circuit breaker or other disconnecting device.

Electrical Input Requirements

Operate the welding power source from a single or three-phase 50/60 Hz, AC power supply. The input voltage must match one of the electrical input voltages shown on the input data label on the unit nameplate. Contact the local electric utility for information about the type of electrical service available, how proper connections should be made, and inspection required. The line disconnect switch provides a safe and convenient means to completely remove all electrical power from the welding power supply whenever necessary to inspect or service the unit.



NOTE!

This unit is equipped with a three-conductor with earth power cable that is connected at the welding power source end for single or three-phase electrical input power.

Do not connect an input (WHITE, BLACK or RED) conductor to the ground terminal.

Do not connect the ground (GREEN) conductor to an input line terminal.

Refer to Figure 3-1 and:

1. Connect end of ground (GREEN) conductor to a suitable ground. Use a grounding method that complies with all applicable electrical codes.
2. For 3- phase operation, connect ends of line 1 (BLACK) and line 2 (WHITE) and line 3 (RED) input conductors to a de-energized line disconnect switch.
For 1- phase operation, connect BLACK and WHITE input conductors. Insulate the RED Conductor.
3. Use Table 3-1 as a guide to select line fuses for the disconnect switch.

Input Voltage	Fuse Size	
	1 Phase	3 Phase
208 VAC	100 Amps	60 Amps
230 VAC	80 Amps	50 Amps
460 VAC	50 Amps	30 Amps

Table 3-1 Electrical Input Connections



NOTE!

Fuse size is based on not more than 200 percent of the rated input amperage of the welding power source (Based on Article 630, National Electrical Code).

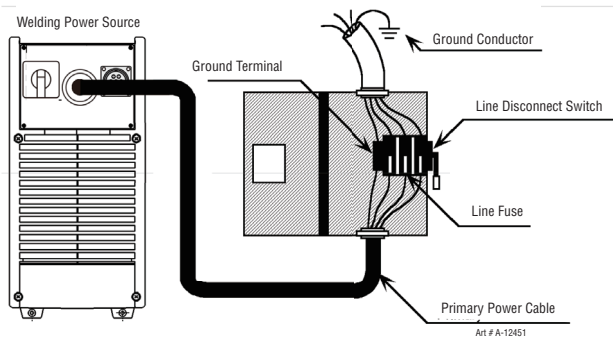

Figure 3-1 Electrical Input Connections

Input Power

Each unit incorporates an INRUSH circuit and input voltage sensing circuit. When the MAIN SWITCH is turned ON, the inrush circuit provides a pre-charging of the input capacitors. A relay in the Main Power PCB2 will turn on after the input capacitors have charged to operating voltage (after approximately 5 seconds).



NOTE!

Note the available input power. Damage to the PCB could occur if 575VAC or higher is applied.

3.05 High Frequency Introduction

The importance of correct installation of high frequency welding equipment cannot be overemphasized. Interference due to high frequency initiated or stabilized arc is almost invariably traced to improper installation. The following information is intended as a guide for personnel installing high frequency welding machines.



WARNING EXPLOSIVES

The high frequency section of this machine has an output similar to a radio transmitter. The machine should NOT be used in the vicinity of blasting operations due to the danger of premature firing.



WARNING COMPUTER

It is also possible that operation close to computer installations may cause computer malfunction.

3.06 High Frequency Interference

Interference may be transmitted by a high frequency initiated or stabilized arc welding machine in the following ways.

1. **Direct Radiation:** Radiation from the machine can occur if the case is metal and is not properly grounded. It can occur through apertures such as open access panels. The shielding of the high frequency unit in the Power Source will prevent direct radiation if the equipment is properly grounded.
2. **Transmission via the Supply Lead:** Without adequate shielding and filtering, high frequency energy may be fed to the wiring within the installation (mains) by direct coupling. The energy is then transmitted by both radiation and conduction. Adequate shielding and filtering is provided in the Power Source.
3. **Radiation from Welding Leads:** Radiated interference from welding leads, although pronounced in the vicinity of the leads, diminishes rapidly with distance. Keeping leads as short as possible will minimize this type of interference. Looping and suspending of leads should be avoided wherever possible.
4. **Re-Radiation from Unearthed Metallic Objects:** A major factor contributing to interference is re-radiation from unearthed metallic objects close to the welding leads. Effective grounding of such objects will prevent re-radiation in most cases.

3.07 Electromagnetic Compatibility



WARNING

Extra precautions for Electromagnetic Compatibility may be required when this Welding Power Source is used in a domestic situation.

A. Installation and Use - Users Responsibility

The user is responsible for installing and using the welding equipment according to the manufacturer's instructions. If electromagnetic disturbances are detected then it shall be the responsibility of the user of the welding equipment to resolve the situation with the technical assistance of the manufacturer. In some cases this remedial action may be as simple as earthing the welding circuit, see NOTE below. In other cases it could involve constructing an electromagnetic screen enclosing the Welding Power Source and the work, complete with associated input filters. In all cases, electromagnetic disturbances shall be reduced to the point where they are no longer troublesome.



NOTE!

The welding circuit may or may not be earthed for safety reasons. Changing the earthing arrangements should only be authorised by a person who is competent to assess whether the changes will increase the risk of injury, e.g. by allowing parallel welding current return paths which may damage the earth circuits of other equipment. Further guidance is given in IEC 60974-13 Arc Welding Equipment - Installation and use (under preparation).

B. Assessment of Area

Before installing welding equipment, the user shall make an assessment of potential electromagnetic problems in the surrounding area. The following shall be taken into account

1. Other supply cables, control cables, signalling and telephone cables; above, below and adjacent to the welding equipment.
2. Radio and television transmitters and receivers.
3. Computer and other control equipment.
4. Safety critical equipment, e.g. guarding of industrial equipment.
5. The health of people around, e.g. the use of pacemakers and hearing aids.
6. Equipment used for calibration and measurement.
7. The time of day that welding or other activities are to be carried out.
8. The immunity of other equipment in the environment: the user shall ensure that other equipment being used in the environment is compatible: this may require additional protection measures.

The size of the surrounding area to be considered will depend on the structure of the building and other activities

that are taking place. The surrounding area may extend beyond the boundaries of the premises.

C. Methods of Reducing Electromagnetic Emissions

1. **Mains Supply**
Welding equipment should be connected to the mains supply according to the manufacturer's recommendations. If interference occurs, it may be necessary to take additional precautions such as filtering of the mains supply. Consideration should be given to shielding the supply cable of permanently installed welding equipment in metallic conduit or equivalent. Shielding should be electrically continuous throughout its length. The shielding should be connected to the Welding Power Source so that good electrical contact is maintained between the conduit and the Welding Power Source enclosure.
2. **Maintenance of Welding Equipment**
The welding equipment should be routinely maintained according to the manufacturer's recommendations. All access and service doors and covers should be closed and properly fastened when the welding equipment is in operation. The welding equipment should not be modified in any way except for those changes and adjustments covered in the manufacturer's instructions. In particular, the spark gaps of arc striking and stabilising devices should be adjusted and maintained according to the manufacturer's recommendations.
3. **Welding Cables**
The welding cables should be kept as short as possible and should be positioned close together, running at or close to the floor level.
4. **Equipotential Bonding**
Bonding of all metallic components in the welding installation and adjacent to it should be considered. However, metallic components bonded to the work piece will increase the risk that the operator could receive a shock by touching the metallic components and the electrode at the same time. The operator should be insulated from all such bonded metallic components.
5. **Grounding of the Workpiece**
Where the workpiece is not bonded to earth for electrical safety, nor connected to earth ground because of its size and position, e.g. ship's hull or building steelwork, a connection bonding the workpiece to earth ground may reduce emissions in some, but not all instances. Care should be taken to prevent the grounding of the workpiece increasing the risk of injury to users, or damage to other electrical equipment. Where necessary, the connection of the workpiece to earth should be made by direct connection to the workpiece, but in some countries where direct connection is not permitted, the bonding should be achieved by suitable capacitance, selected according to national regulations.
6. **Screening and Shielding**
Selective screening and shielding of other cables and equipment in the surrounding area may alleviate problems of interference. Screening the entire welding installation may be considered for special applications.

3.08 Power Source Controls, Indicators and Features

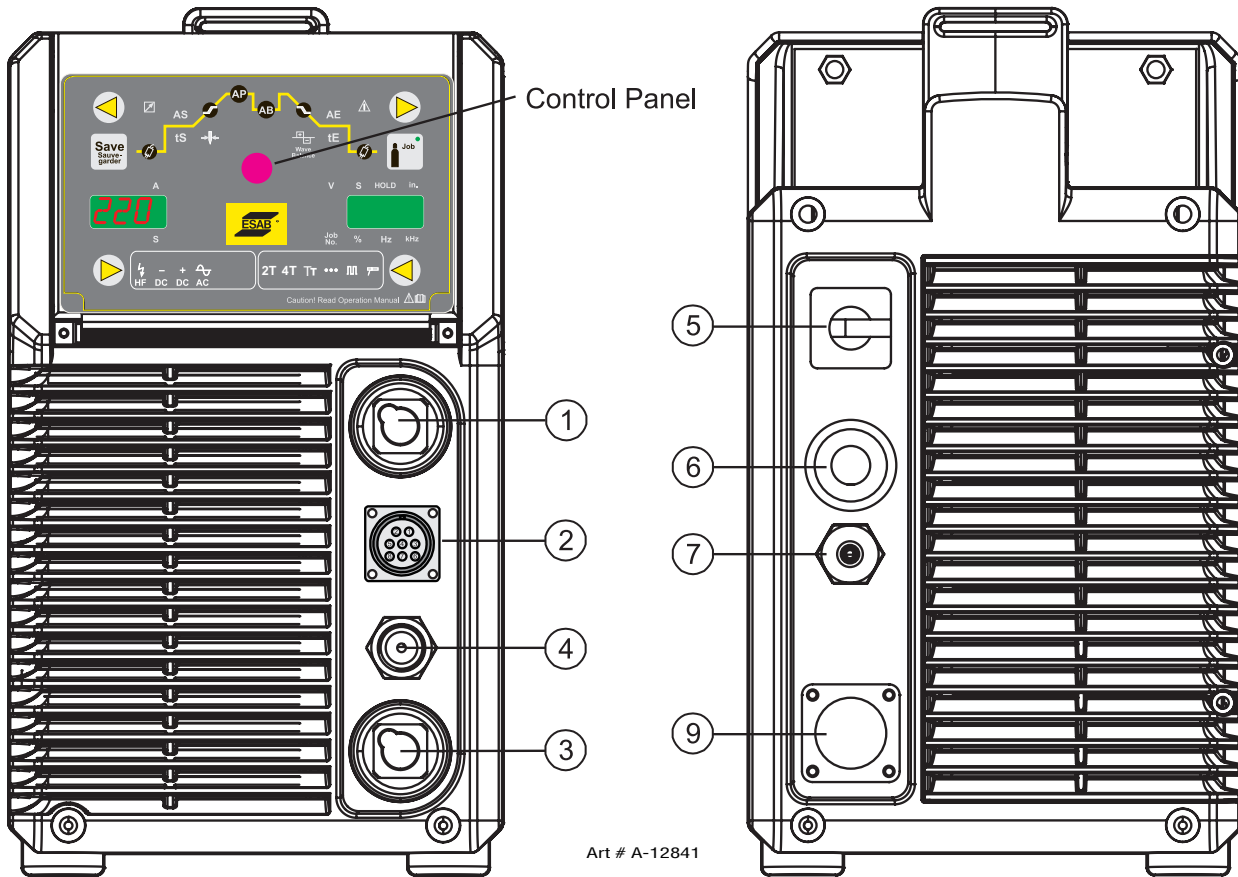

Figure 3-2: Controls on Front and Rear Panel

1. Electrode Welding Terminal

Electrode Welding Terminal. Welding current flows from the Power Source via 50mm Dinse type terminals. It is essential, however, that the male plug is inserted and turned securely to achieve a sound electrical connection.

2. 8 Pin Control Socket

The 8 pin receptacle is used to connect a trigger switch or remote control to the welding Power Source circuitry:

To make connections, align keyway, insert plug, and rotate threaded collar fully clockwise. The socket information is included in the event the supplied cable is not suitable and it is necessary to wire a plug or cable to interface with the 8 pin receptacle.

Socket Pin	Part Number / Description
1	Not used
2	Trigger Switch Input
3	Trigger Switch Input
4	Not used
5	Remote Control Potentiometers Maximum
6	Remote Control Potentiometers Minimum
7	Remote Control Potentiometer Wiper
8	Not used

Table 3-1: 8 Pin Interconnection Control Plug Configuration

Figure 3-3: 8 Pin Control Socket

3. Worklead Welding Terminal

Worklead Welding Terminal. Welding current flows from the Power Source via 50mm Dinse type terminals. It is essential, however, that the male plug is inserted and turned securely to achieve a sound electrical connection.



CAUTION

Loose welding terminal connections can cause overheating and result in the male plug being fused in the terminal.

4. Shielding Gas Outlet

The Shielding Gas Outlet located on the front panel is a 5/8"-18 UNF female gas fitting and is utilized for the connection of a suitable TIG Torch.

5. Power On/Off Switch

This Switch is located on the rear of the Power Source and turns mains power off and on.



WARNING

When the front digital displays are lit, the machine is connected to the Mains supply voltage and the internal electrical components are at Mains voltage potential.

6. Mains Supply Lead

The ET 220i AC/DC is fitted with a heavy duty mains supply lead, 10ft long cable, no plug.

7. Gas Inlet

The Shielding Gas Inlet connection is used to supply the appropriate shielding gas to the unit. The gas inlet is located on the rear of the Power Source. It is 5/8"-18 UNF female inert gas connection.



WARNING

Only Inert Shielding Gases specifically designed for welding applications should be used.

9. Remote Control Socket (Automation)

The 14 pin Automation Remote Control Socket is used to connect remote control devices to the welding power source.

To make connections, align keyway, insert plug, and rotate threaded collar fully clockwise.

The Automation Remote Control Socket is located on the rear of the Power Source.

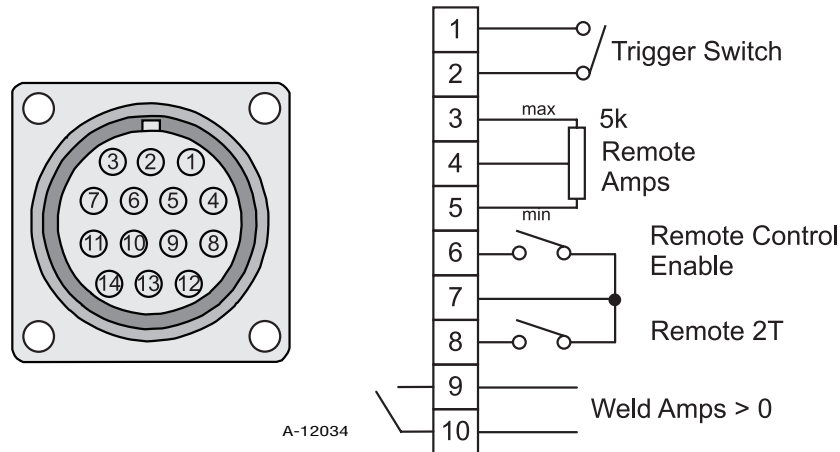

Figure 3-4: 14 Pin Remote Control Socket

ET 220I AC/DC

Socket Pin	Part Number / Description
1	Trigger Switch Input
2	Trigger Switch Input
3	Remote Control 5k ohm Potentiometers Maximum
4	Remote Control 5k ohm Potentiometers Wiper
5	Remote Control 5k ohm Potentiometers Minimum
6	Remote Control Enable (Short to common to enable remote control)
7	Common
8	Remote 2T (short to common to select remote control action only)
9	Volt free relay contact, Weld Amps > 0A
10	Volt free relay contact, Weld Amps > 0A
11	Not used
12	Not used
13	Not used
14	Not used

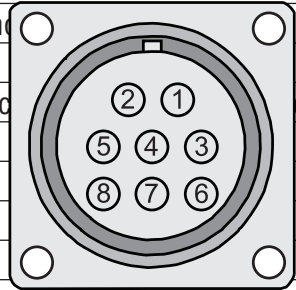

Table 3-2: 14 Pin Interconnection Control Plug Configuration

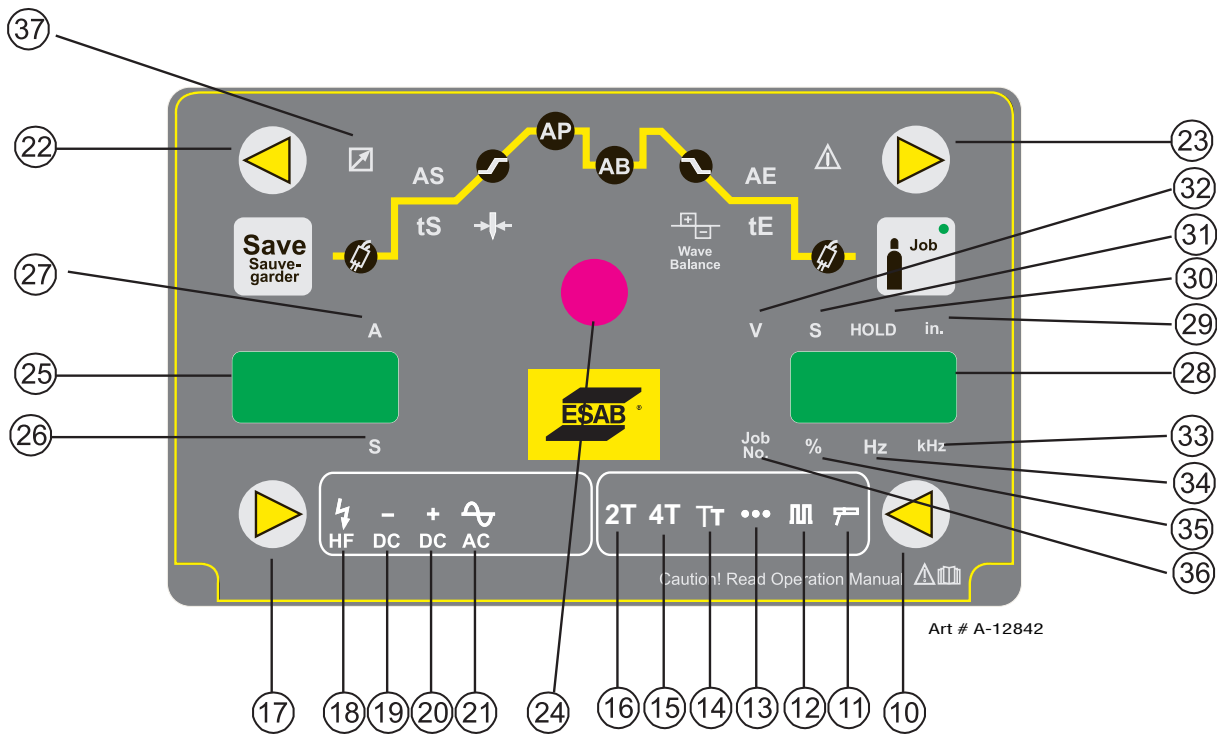

Figure 3-5: Control Panel Weld Mode & Meter Displays

10. Welding Mode Button

Press the MODE button to select the Welding Process mode. Available modes are GTAW 2T, GTAW 4T, GTAW Spot, GTAW Pulse 2T, GTAW Pulse 4T, TIPTRONIC, TT and SMAW.

11. SMAW indicator light

This light will illuminate when the power source is in SMAW welding mode.

12. Pulse indicator light

This light will illuminate when the power source is in GTAW Pulse 2T or 4T welding mode.

13. Spot indicator light

This light will illuminate when the power source is in GTAW SPOT welding mode.

14. Tiptronic indicator light (Refer to Section 3.12)

This light will illuminate when the power source is in TIPTRONIC welding mode and a saved job has been loaded.

15 4T (latch) indicator light

This light will illuminate when the power source is in GTAW 4T welding mode.

This mode of welding is mainly used for long welding runs to reduce operator fatigue. In this mode the operator can press and release the torch trigger and the output will remain active. To deactivate the power source, the trigger switch must again be depressed and released, thus eliminating the need for the operator to hold the torch trigger.

Note that when operating in GTAW (TIG mode), the power source will remain activated until the selected downslope time has elapsed.

16. 2T (normal) indicator light

This light will illuminate when the power source is in GTAW 2T welding mode.

In this mode, the torch trigger must remain depressed for the welding output to be active. Press and hold the torch trigger to activate the power source (weld). Release the torch trigger switch to cease welding.

17. Welding Type Button

Press the TYPE button to select the Welding Type mode, i.e. current mode. Selects the welding current type DC, AC with/without HF ignition.

In SMAW (Stick) mode, the available modes are Electrode DC-, Electrode DC+.

In GTAW (Tig) mode, the available modes are Electrode DC-, HF Electrode DC-, AC and HF AC.

18. HF (high frequency) indicator light

This light will illuminate when the power source is in GTAW 2T or 4T HF welding mode.

19. Electrode Negative indicator light

This light will illuminate when the power source is in Electrode Negative welding mode on the top welding terminal. (DC Output)

20. Electrode Positive indicator light

This light will illuminate when the power source is in Electrode Positive welding mode on the top welding terminal. (DC Output)

21. Electrode AC indicator light (only for AC/DC)

This light will illuminate when the power source is in Electrode AC welding mode on the top welding terminal. (AC Output)

22. BACK Welding Parameter Button

Press the BACK welding parameter button to scroll left through the available welding parameters.

23. FORWARD Welding Parameter Button

Press the FORWARD welding parameter button to scroll right through the available welding parameters.

24. Multi Function Control

Turn the MULTI FUNCTION CONTROL to adjust the available welding parameters.

When not welding, the Multi Function Control is used to adjust all welding parameters, including welding amps. A short press on the Scroll Left or Scroll Right button will save the welding parameter value, then increment / decrement to the next available welding parameter. The welding parameter LED will illuminate and the Multi Function Control will then adjust the selected welding parameter. The parameter code and parameter value are shown on the meters and the LED's next to the meter indicate if the parameter is Amps, Seconds, Inches, %, kHz or Hz.

During welding, adjustment of the Multi Function Control will adjust the selected parameter.

ET 220I AC/DC

25. Digital Ammeter / Parameter Codes

The digital amperage meter is used to display both the pre-set current and actual output current of the power source. It is also used to display Welding Parameter Codes.

Depending on the Welding Parameter selected, the status indicator adjacent to the ammeter will illuminate to show the units of the welding parameter.

When welding, the amperage meter will display actual welding current.

At the completion of welding, the amperage meter will hold the last recorded amperage value for a period of approximately 10 seconds. The amperage meter will hold the value until; (1) any of the front panel controls are adjusted in which case the unit will revert to preview mode, (2) welding is recommenced, in which case actual welding amperage will be displayed, or (3) a period of 10 seconds elapses following the completion of welding in which case the unit will return to preview mode.

26. Seconds indicator light

This light will illuminate when Seconds are being shown on the Digital Ammeter Display.

27. Amps indicator light

This light will illuminate when Amps are being shown on the Digital Ammeter Display.

28. Digital Voltmeter / Parameter meter

The digital volt meter is used to display the actual output voltage of the power source. It is also used to display Welding Parameters.

Depending on the Programming Parameter selected, the status indicator adjacent to the volt meter will illuminate to show the units of the welding parameter.

When welding, the volt meter will display actual welding voltage.

At the completion of welding, the volt meter will hold the last recorded voltage value for a period of approximately 10 seconds. The volt meter will hold the value until; (1) any of the front panel controls are adjusted, (2) welding is recommenced, or (3) a period of 10 seconds elapses following the completion of welding.

29. Inch indicator light

This light will illuminate when "Inches (")" are being shown on the Digital Volt meter Display for electrode diameter size.

30. HOLD indicator light

This light will illuminate when the HOLD function is active on the Digital Display at the completion of welding.

31. Seconds indicator light

This light will illuminate when Seconds are being shown on the Digital Volt meter Display.

32. Volts indicator light

This light will illuminate when Volts are being shown on the Digital Volt meter Display.

33. kHz (frequency) indicator light

This light will illuminate when kHz (frequency) is being shown on the Digital Volt meter Display.

34. Hz (frequency) indicator light

This light will illuminate when Hz (frequency) is being shown on the Digital Volt meter Display.

35. % (percentage) indicator light

This light will illuminate when % (percentage) is being shown on the Digital Volt meter Display.

36. Job Number indicator light

This light will illuminate when Job Number is being shown on the Digital Volt meter Display.

37. Remote Control indicator light

This light will illuminate when the Remote Control is active.

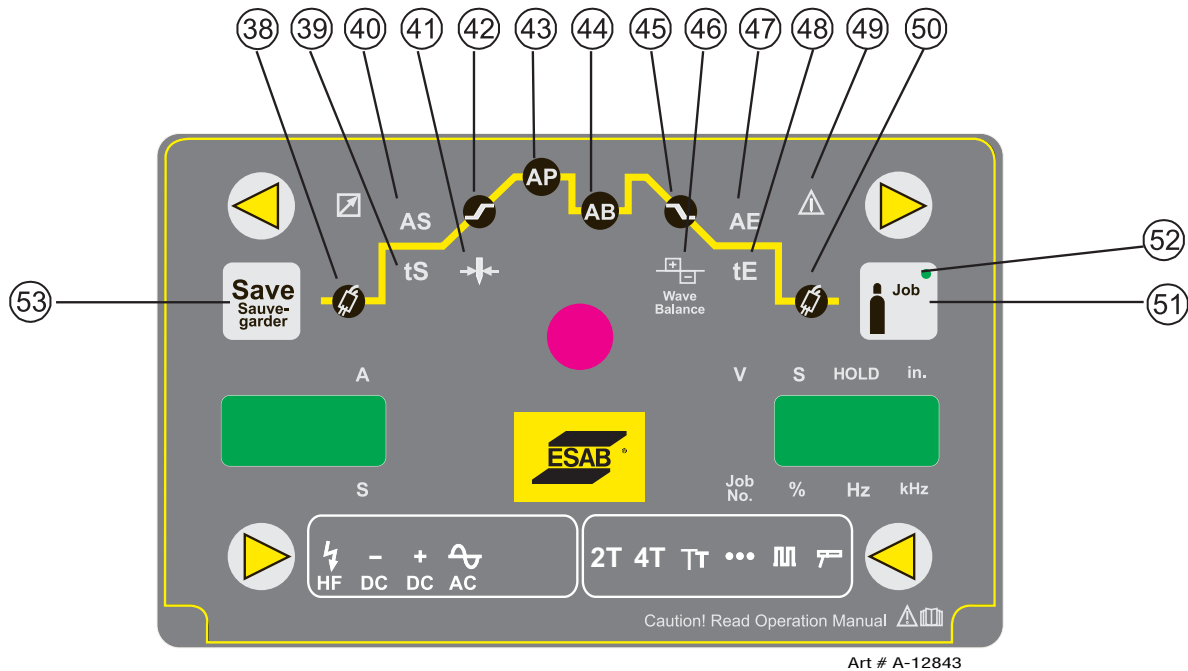

Figure 3-6: Control Panel

38. Pre Flow indicator light

This light will illuminate when the Pre Flow Welding Parameter is selected.

39. Initial Current time (GTAW) and Hot Start time (SMAW) indicator light

This light will illuminate when the Initial Current Time Welding Parameter is selected in GTAW mode, or when Hot Start Time Welding Parameter is selected in SMAW mode.

40. Initial Current amps (GTAW) and Hot Start amps (SMAW) indicator light

This light will illuminate when the Initial Current Amps Welding Parameter is selected in GTAW mode, or when Hot Start Amps Welding Parameter is selected in SMAW mode.

41. Electrode Diameter indicator light

This light will illuminate when the Electrode Diameter Welding Parameter is selected.

42. Up Slope indicator light

This light will illuminate when the Up Slope Welding Parameter is selected.

43. Peak Current indicator light

This light will illuminate when the Peak Current Welding Parameter is selected.

44. Background Current indicator light

This light will illuminate when the Background Current Welding Parameter is selected.

45. Down Slope indicator light

This light will illuminate when the Down Slope Welding Parameter is selected.

46. AC Balance indicator light

This light will illuminate when the AC Balance Welding Parameter is selected.

47. Crater Current indicator light

This light will illuminate when the Crater Current Welding Parameter is selected.

ET 220I AC/DC

48. Crater Current time indicator light

This light will illuminate when the Crater Current Time Welding Parameter is selected.

49. Electrode Diameter Out-of-Range indicator light

This light will illuminate when the set welding current is outside the normal operating range for the selected Electrode Diameter.

50. Post Flow indicator light

This light will illuminate when the Post Flow Welding Parameter is selected.

51. Gas Purge Button

Press the button once to active that gas valve and then press it again to turn it off, also if you press and release this button the gas will purge for 30 seconds and then turn off.

52. Tip Tronic indicator light (Refer to Section 3.13)

This light will illuminate when an active TipTronic job is selected.

53. Save Tip Tronic Job Button

Press the SAVE button to save the current TipTronic Job settings in the selected memory location

Up to 100 jobs can be saved arranged as 10 banks of 10 jobs.

3.09 Setup for TIG (GTAW) Welding

- Select a GTAW operation mode with the welding mode & welding type buttons (refer to Section 3.10 for further information).
- Connect the TIG Torch to the Electrode welding terminal (top). Welding current flows from the power source via Dinse type terminals. It is essential, however, that the male plug is inserted and turned securely to achieve a sound electrical connection.
- Connect the work lead to the Worklead welding terminal (bottom). Welding current flows from the Power Source via Dinse type terminals. It is essential, however, that the male plug is inserted and turned securely to achieve a sound electrical connection.



CAUTION

Loose welding terminal connections can cause overheating and result in the male plug being fused in the Dinse terminal.

- Connect the TIG torch trigger switch via the 8 pin socket located on the front of the power source as shown below. The TIG torch will require a trigger switch to operate in Liftarc TIG or HF TIG Mode.



NOTE!

If the TIG torch has a remote TIG torch current control fitted then it will require to be connected to the 8 pin socket. (Refer to section 3.08 Remote Control Socket for further information).

- Fit the welding grade shielding gas regulator/flowmeter to the shielding gas cylinder (refer to Section 3.19) then connect the shielding gas hose from the regulator/flowmeter outlet gas INLET on the rear of the Power Source. Connect the gas hose from the TIG torch to the gas OUTLET on the front of the Power Source.



WARNING

Before connecting the work clamp to the work make sure the mains power supply is switched off.



Secure the welding grade shielding gas cylinder in an upright position by chaining it to a suitable stationary support to prevent falling or tipping.

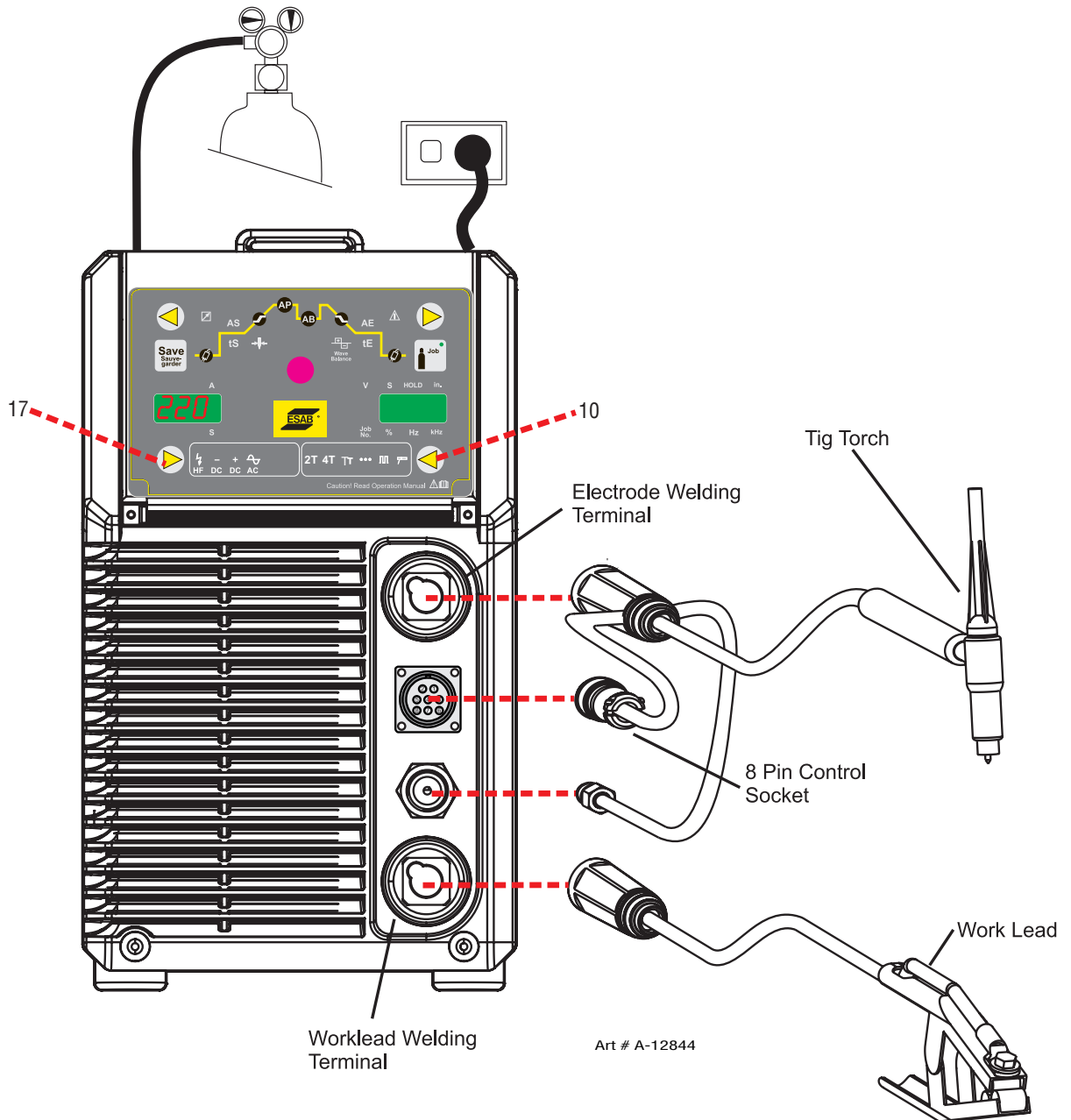

Figure 3-7: Setup for TIG Welding

ET 220I AC/DC

- First, select a Welding Type by pressing the Weld Type (17) button.

Welding Type	Welding Type Selection
DC HF TIG	
AC Liftarc TIG	
DC Liftarc TIG	
AC HF TIG	

- Then, select a Welding Mode by pressing the WELDING MODE (10) button.

Welding Mode	Welding Mode Selection
2T (Normal Mode)	
4T (Latch Mode)	
Tip Tronic (used to recall saved jobs)	
Spot Mode	
2T Pulse Welding (Normal Mode)	
4T Pulse Welding (Latch Mode)	

3.10 TIG (GTAW) Programming Mode

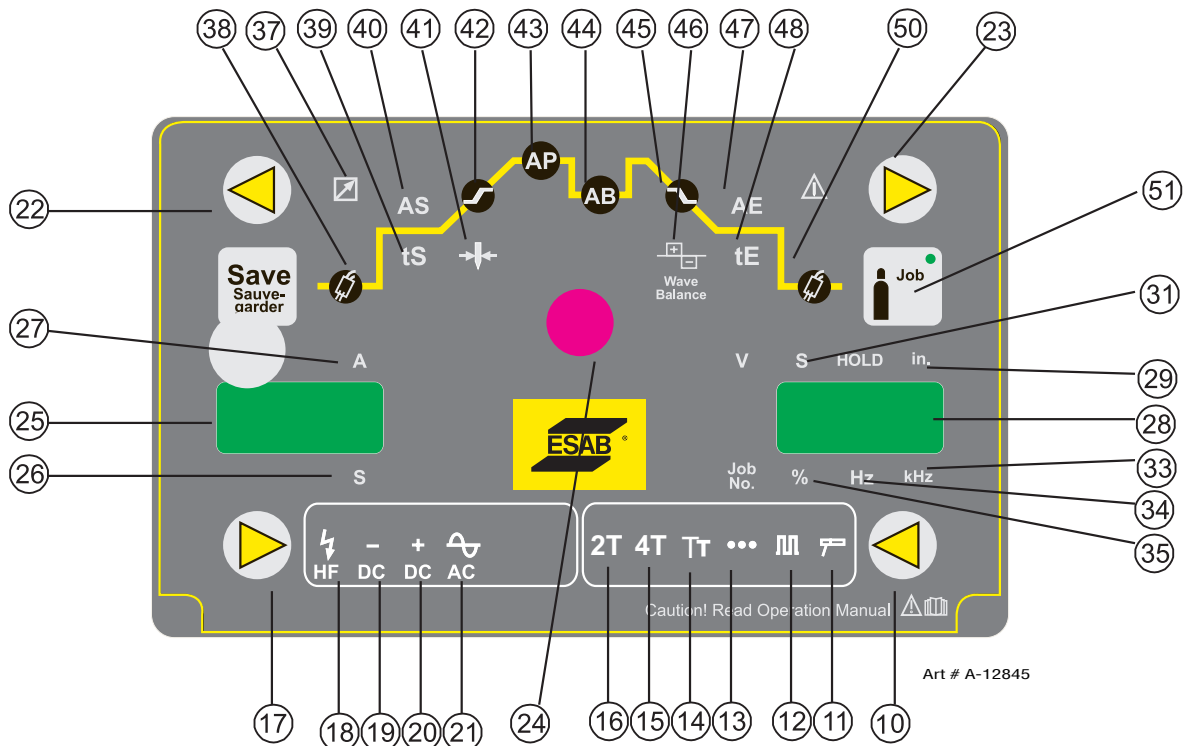

Figure 3-8: TIG Programming Mode

- Press the WELDING MODE (10) button to select the appropriate GTAW mode.
Several GTAW operating modes are available.
 - 2T (normal mode). The 2T LED (16) will illuminate.
 - 4T (latch mode). The 4T LED (15) will illuminate.
 - Tiptronic. The TIPTRONIC LED (14) will illuminate
 - SPOT mode. The SPOT LED (13) will illuminate.
 - 2T PULSE (normal mode). The 2T LED (16) and PULSE LED (12) will illuminate.
 - 4T PULSE (latch mode). The 4T LED (15) and PULSE LED (12) will illuminate.
- Press the WELDING TYPE (17) button to select the welding output type
Several GTAW operating modes are available.
 - AC welding output mode. The AC LED (21) will illuminate.
 - DC Negative welding output mode. The DC Negative LED (19) will illuminate.
 - HF AC welding output mode. The HF LED (18) and the AC LED (21) will illuminate.
 - HF DC Negative welding output mode. The HF LED (18) and the DC Negative LED (19) will illuminate.



WARNING

In HF operating mode, high voltage pulses are generated within the power source, to provide contactless initiation of the GTAW welding arc. If HF operating mode is selected, high voltage will be present on the tungsten electrode when the trigger is pressed. Never touch the tungsten welding electrode of any parts in the welding circuit when the trigger is pressed..

- Press the BACK button (22) or FORWARD button (23) so the Electrode Diameter LED (41) and Inches LED (29) are illuminated.
Use the Multi Function Control (24) to adjust the Electrode size being used.
- Press the BACK button (22) or FORWARD button (23) until the Peak Current LED (43) is illuminated.
Use the Multi Function Control (24) to adjust the Welding Current for the Electrode size being used. If the Welding Current does not match the normal operating range of the electrode the Electrode Diameter Out-of-Range indicator LED (49) will illuminate.
If the Electrode Diameter Out-of-Range indicator LED (49) is illuminated, it is still possible to weld.

ET 220i AC/DC

Note that other parameters may need to be set, according to the operating mode selected, Please refer to the tables below.

GTAW Electrode Diameter (inches)	Nominal Welding Current (A) DC	Nominal Welding Current (A) AC
0.040" (1.0mm)	5 - 40 Amps	5 - 30 Amps
1/16" (1.6mm)	15 - 130 Amps	20 - 90 Amps
3/32" (2.4mm)	70 - 240 Amps	70 - 180 Amps
1/8" (3.2mm)	140 - 320 Amps	130 - 250 Amps

Table 3-3: Normal Welding Current for GTAW Electrode size

Note that Normal recommended Welding Current AC Amps are dependent on the type of electrode and on the AC Balance Parameter setting.

Parameter	Range	LED Code (Left Display)	Parameter Value (Right Display)	Factory Setting
Shielding Gas Pre-Flow time This parameter operates in GTAW modes only and is used to provide gas to the weld zone prior to striking the arc, once the torch trigger switch has been pressed. This control is used to dramatically reduce weld porosity at the start of a weld.	0.1-10.0 seconds		S 	0.1
Start Current AS This parameter operates in GTAW modes only and is used to set the start current for TIG. In 4T mode the Initial Current remains on until the torch trigger switch is released after it has been depressed. In 2T mode the Initial Current remains on for the Start Current Time tS and then the Up Slope current ramp will commence.	5 – 200% of Welding Current A1 The maximum welding current in GTAW mode is limited to 220A for the ET 220i AC/DC.	A When A1=100A	 %	50
Start Current Time tS (2T normal mode only) This parameter operates in 2T GTAW modes only and set the time the Start Current is active, after which the Up Slope current ramp will commence.	0 - 20 seconds		S 	0.1
Up Slope Time This parameter operates in GTAW modes only and is used to set the time for the weld current to ramp up from Initial current to welding current.	0 - 99%	 S	 %	5
Welding Current A1 ET 220i AC/DC	3 - 220 A	A 	V 	100

Parameter	Range	LED Code (Left Display)	Parameter Value (Right Display)	Factory Setting
<p>Back Ground Current</p> <p>This parameter operates in GTAW Pulse modes only and sets the GTAW Back Ground Current. The lowest point in the pulse is called the Trough.</p>	1 – 200% of Welding Current A1 The maximum welding current in GTAW mode is limited to 220A for the ET 220i AC/DC.	A 50	50 %	50
<p>Down Slope Time</p> <p>This parameter operates in GTAW modes only and is used to set the time for the weld current to ramp down to the crater current. This control is used to eliminate the crater that can form at the completion of a weld.</p>	0 – 99%	3.0 s	20 %	20
<p>Crater Current AE</p> <p>This parameter operates in GTAW modes only. This is the current at the end of the down slope current ramp. The welding current will remain at the Crater Current value until the Crater Current Time has elapsed, at which time the welding current will cease and the unit will enter Post Flow mode. This control is used to eliminate the crater that can form at the completion of a weld.</p>	5 – 200% of Welding Current A1 The maximum welding current in GTAW mode is limited to 220A for the ET 220i AC/DC.	A 25	25 %	25
<p>Crater Current Time tE</p> <p>This parameter operates in GTAW modes only and is used to set the time for the crater current before entering post flow mode. This control is used to eliminate the crater that can form at the completion of a weld.</p>	0 – 20 seconds		s 0.2	0.2
<p>Shielding Gas Post-Flow time</p> <p>This parameter operates in GTAW modes only and is used to adjust the post gas flow time once the arc has extinguished. This control is used to dramatically reduce oxidation of the tungsten electrode.</p>	20 – 500%	5.0 s	100 %	100

ET 220i AC/DC





















Parameter	Range	LED Code (Left Display)	Parameter Value (Right Display)	Factory Setting
<p>AC balance (AC Output Mode only)</p> <p>This parameter operates in AC GTAW modes and is used to set the penetration to cleaning action ratio for the AC weld current. Generally WAVE BALANCE is set to 50% for AC Stick welding. The WAVE BALANCE control changes the ratio of penetration to cleaning action of the AC TIG welding arc. Maximum weld penetration is achieved when the WAVE BALANCE control is set to 10%. Maximum cleaning of heavily oxidised aluminium or magnesium alloys is achieved when the WAVE BALANCE control is set to 65%.</p>	10 – 90% positive welding current		 35 %	35
<p>Electrode Diameter</p> <p>ET 220i AC/DC Set this parameter to the tungsten electrode size being used.</p>	.040" – 1/8"		 Inch 3/32"	3/32"
<p>AC frequency</p> <p>This parameter operates in AC mode only and is used to set the frequency for the AC weld current</p>	30 – 200Hz		 60 Hz	60
<p>Spot Welding Time</p> <p>This parameter sets the spot welding time</p>	0.01 – 10.0 seconds		 S 1.0	1.0
<p>Spot Welding Dwell Time (only available with Spot Welding Dwell Time enabled, refer to secondary parameters)</p> <p>This parameter sets the dwell (off) time between repeated spot welds (Refer to Section 3.12).</p>	0.09 – 60.0 seconds		 S 1.0	1.0
<p>Pulse Frequency</p> <p>This parameter sets the Pulse Frequency when in GTAW Pulse operating mode.</p>	0.2 – 2000Hz		 2.0 Hz	2
<p>Pulse Balance</p> <p>This parameter sets the percentage "on" time of the Pulse Frequency for welding weld current when in Pulse operating mode</p>	1 – 99% of Welding Current A1		 50 %	50

Table 3-4: GTAW Main Parameters

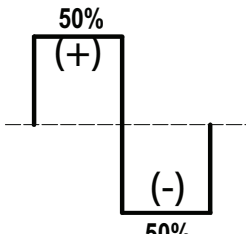
AC BALANCE is used for aluminium welding in AC HF GTAW or AC LIFT GTAW operating modes. It is used to set the ratio of penetration to cleaning action for the AC GTAW welding arc. Maximum weld penetration is achieved when the AC BALANCE is set to 10%. Maximum cleaning of heavily oxidized aluminium or magnesium alloys is achieved when the WAVE BALANCE is set to 90%.

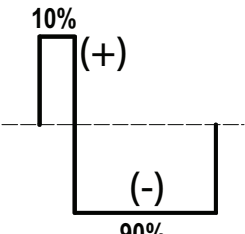
AC Balance = 50%	AC Balance = 10%	AC Balance = 65%
 <p data-bbox="430 567 714 619">Balanced with 50% penetration and 50% cleaning</p> 	 <p data-bbox="755 567 998 619">Maximum Penetration and reduced cleaning</p> 	 <p data-bbox="1079 567 1307 619">Maximum Cleaning and reduced penetration</p> 

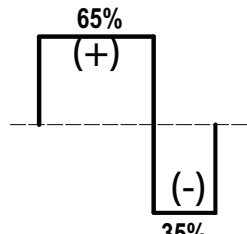
A-12057

Table 3-5: AC GTAW Wave Balance

3.11 TIG (GTAW) Welding Secondary Parameters

Secondary parameters are available. These are required to be set separately.

- Press and hold the WELDING MODE (10) button then press the SAVE (54) button.
- Press the BACK button (22) or FORWARD button (23) to select the Parameter.
- Use the Multi Function Control (24) to adjust the parameter.
- Press the Welding Mode button to exit this mode.
- Note that some parameters are only available in certain welding modes.

Note that even during welding, these settings can be adjusted and changed.

Parameter	Range	LED Code (Left Display)	Parameter Value (Right Display)	Factory Setting
Ignition Peak Correction The ignition peak current is set after ignition to provide stabilisation of the arc. A different peak current is saved for each selected tungsten electrode diameter.	10-200%			100
Plus terminal Correction Ignition using the positive welding terminal is used for optimum dome formation in AC GTAW welding. A different plus terminal current is saved for each selected tungsten electrode diameter.	10 – 200 %			100
Slope On / Off The up slope and down slope can be disabled. When this feature is set to OFF, current increase, current decrease, initial current and crater current are not available in the main parameters.	ON OFF			ON
Spot Welding Dwell Time (enable / disable) (refer main parameters)	ON OFF			OFF

Table 3-6: GTAW Secondary Parameters

3.12 GTAW Spot Welding Mode with DWELL Time (Stitch Mode)

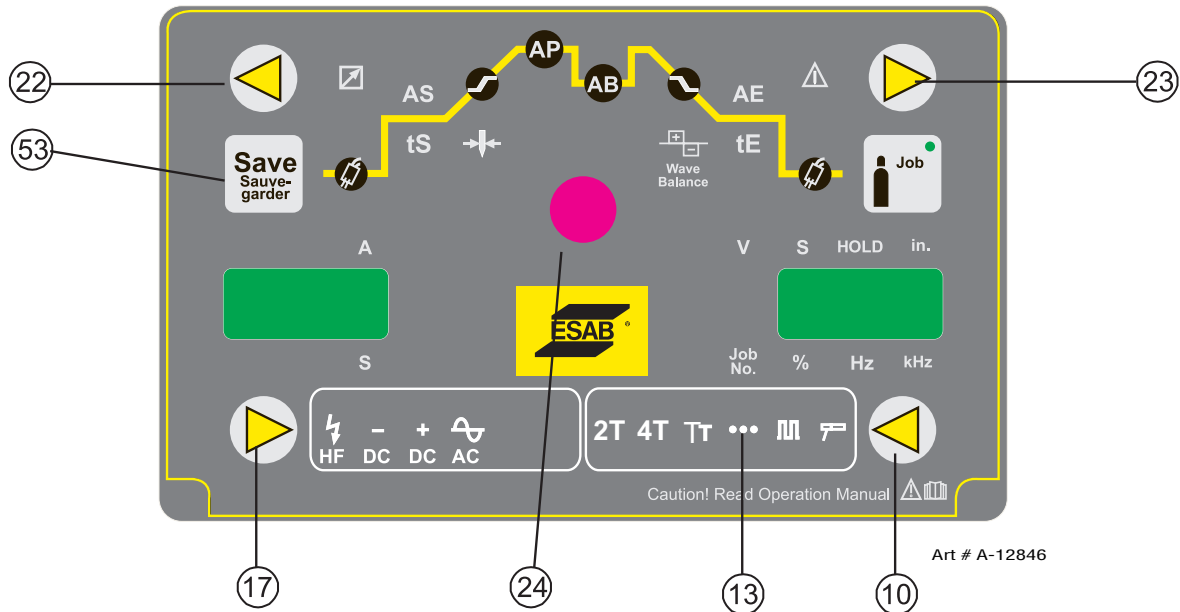

Figure 3-9: GTAW Spot Welding Mode with DWELL Time

To enable Spot Welding with Dwell Time (Stitch welding) the parameter “PSP” needs to be set to ON (refer secondary parameters) it is possible to have automated spot welds with this Stitch function.

In 2T mode, the stitch welds are repeated for as long as the trigger is held in.

In 4T mode, press and release the trigger to start the stitch welds, press and release the trigger to end the stitch welds

The parameters tSP and tSO determine the spot time length and the dwell (off) time length

- Press the WELDING MODE (10) button to select GTAW SPOT mode. SPOT mode. The SPOT LED (13) will illuminate.
- Press the WELDING TYPE (17) button to select the welding output type
- Press the BACK button (22) or FORWARD button (23) so the Electrode Diameter LED (41) and inch LED (29) are illuminated. Use the Multi Function Control (24) to adjust the Electrode size being used.
- Press and hold the WELDING MODE (10) button then press the SAVE (53) button.
- Press the BACK button (22) or FORWARD button (23) to select the “PSP” Parameter.
- Use the Multi Function Control (24) to set “PSP” to ON (to enable stitch welding)
- Press the BACK button (22) or FORWARD button (23) until the Peak Current LED (43) is illuminated.

Use the Multi Function Control (24) to adjust the Welding Current for the Electrode size being used. If the Welding Current does not match the normal operating range of the electrode the Electrode Diameter Out-of-Range indicator LED (49) will illuminate.

- Press the BACK button (22) or FORWARD button (23) until the left display shows “tSP”.
- Use the Multi Function Control (24) to set the required SPOT “ON” time required.
- Press the BACK button (22) or FORWARD button (23) until the left display shows “tSO”.
- Use the Multi Function Control (24) to set the required SPOT “DWELL or OFF” time required.

If the Electrode Diameter Out-of-Range indicator LED (49) is illuminated, it is still possible to weld.

3.13 Tip Tronic Operation

In GTAW modes, up to 100 jobs can be saved. These are arranged as 10 jobs numbers, in 10 job sets. These are shown on the meter displays. The first number on the display is the job set, the second is the job number. In the example, the job set is 2 and the job number is 9.

Saved TipTronic jobs can also be set as active or inactive.

Inactive jobs are skipped during TipTronic job selection.



TipTronic Operation

- Using the Welding Mode button (10) select TipTronic mode (14).
- Use the Multi Function Control (24) to select the job set number and the job number.
Note that if no TipTronic jobs are saved, it will not be possible to select any TipTronic jobs.
- Use the BACK button (22) or FORWARD button (22) to switch between TipTronic jobs and all main parameters.

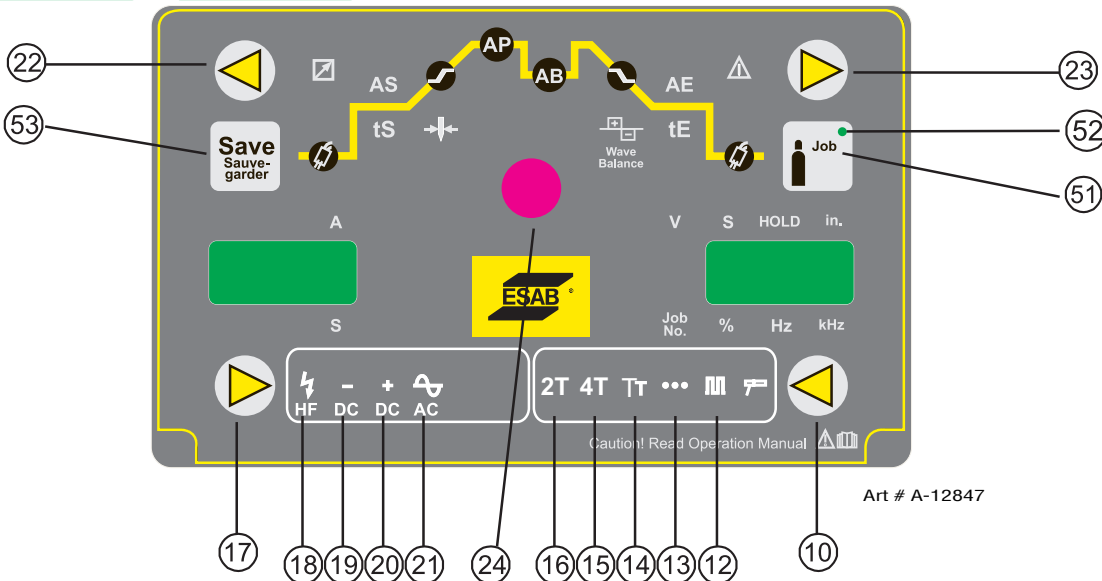

Figure 3-10: Tip Tronic Operation

Save a TipTronic Job (Only TIG parameters can be saved as Tip Tronic jobs)

- Set all the required GTAW welding parameters. Using the Welding Mode button (10) and the Welding Type button (17). Do NOT select TipTronic mode (14) at this stage.
As an example, we may select HF, AC, 4T Pulse GTAW (LED's 18, 21, 16 and 12 will be illuminated).
- Press the SAVE button (53).
The display will show the Job Number identification, the job set and job number.
- Use the Multi Function Control (24) to select the job set number and the job number.
- Press and hold the SAVE button (53) until all LED's illuminate briefly to indicate a Save has been completed.

Note that you can interrupt the Save process, by simply briefly pushing the SAVE button (53)



Load a TipTronic Job

- Using the Welding Mode button (10) select TipTronic mode (14).
Either 2T or the 4T may be lighted as well as the TT symbol for Tip Tronic setting depending on the last saved job.
- Use the Multi Function Control (24) to select the job set number and the job number.

**Set a TipTronic Job as Inactive**

- Press the SAVE button (53).
The display will show the Job Number identification, the job set and job number.
- Use the Multi Function Control (24) to select the job set number and the job number.
- Press the GAS button (51). The light will toggle on and off as you press the button. Press the button so the light is off.
- The TipTronic job is now inactive. Note that the JOB LED (52) will extinguish.
- To exit this mode, press the SAVE button (53).

**Set a TipTronic Job as Active**

- Press the SAVE button (53).
The display will show the Job Number identification, the job set and job number.
- Use the Multi Function Control (24) to select the job set number and the job number.
- Press the GAS button (51). The light will toggle on and off as you press the button. Press the button so the light is on.
- The TipTronic job is now active. Note that the JOB LED (52) will illuminate.
- To exit this mode, press the SAVE button (53).

**Copy a TipTronic Job to another Job Number**

- Using the Welding Mode button (10) select TipTronic mode (14).
- Use the Multi Function Control (24) to select the “source” job set number and the job number.
In our example we are copying from Job Number 2-9.
- Press the SAVE button (53).



- Use the Multi Function Control (24) to select the “destination” job set number and the job number. In our example we are copying to Job Number 6-7.
- Press and hold the SAVE button (54) until all LED's illuminate briefly to indicate a Save has been completed.



3.14 Setup for Stick (SMAW) Welding

- Connect the Electrode Holder lead to the Electrode welding terminal (top). If in doubt, consult the electrode manufacturer. Welding current flows from the Power Source via 50mm Dinse type terminals. It is essential, however, that the male plug is inserted and turned securely to achieve a sound electrical connection.
- Connect the work lead to the Worklead welding terminal (bottom). If in doubt, consult the electrode manufacturer. Welding current flows from the power source via 50mm Dinse type terminals. It is essential, however, that the male plug is inserted and turned securely to achieve a sound electrical connection.
- Select Stick and electrode positive mode with the welding mode and welding type buttons (refer to Section 3.15 for further information)



WARNING

Before connecting the work clamp to the work and inserting the electrode in the electrode holder make sure the mains power supply is switched off..



CAUTION

Remove any packaging material prior to use. Do not block the air vents at the front or rear of the Welding Power Source.



CAUTION

Loose welding terminal connections can cause overheating and result in the male plug being fused in the 50mm Dinse type terminal.

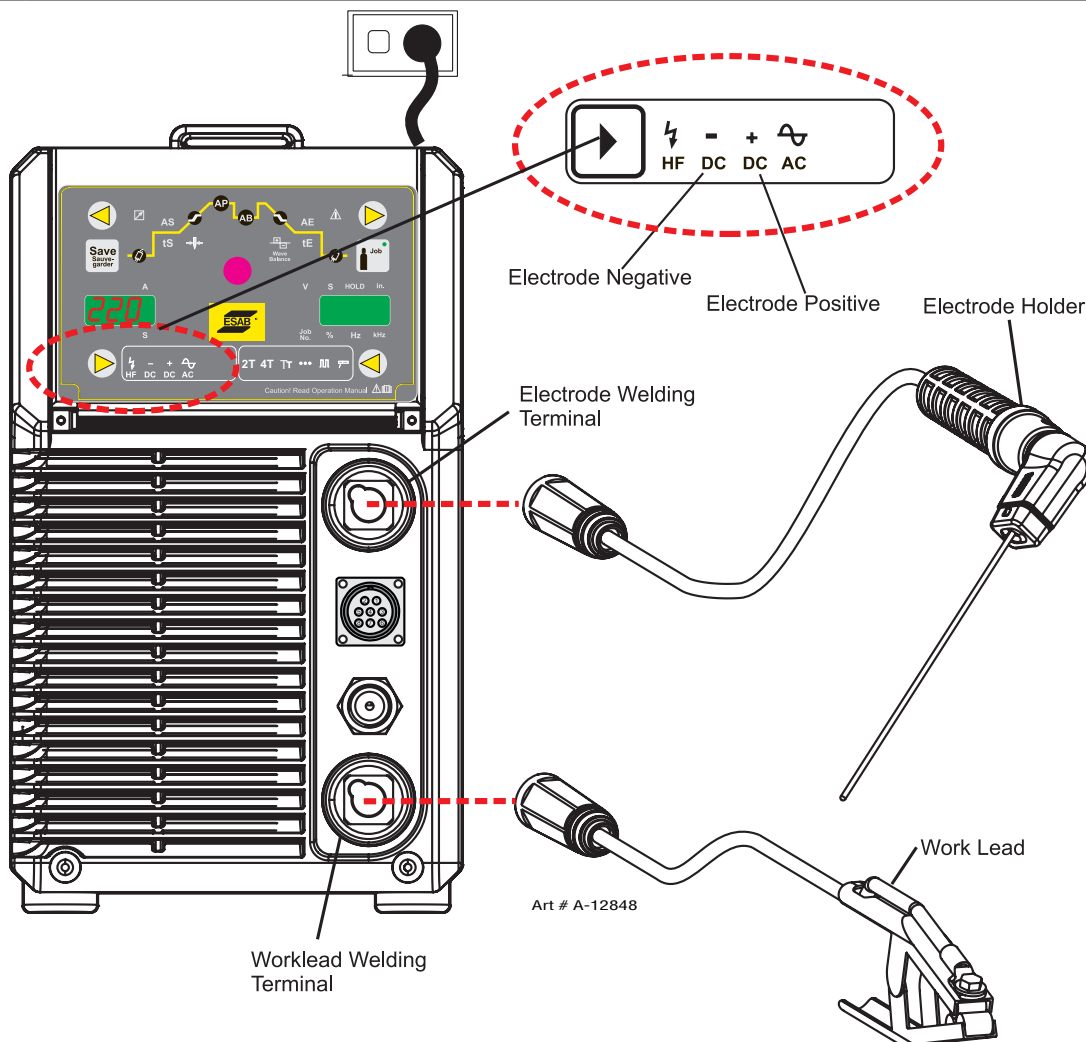
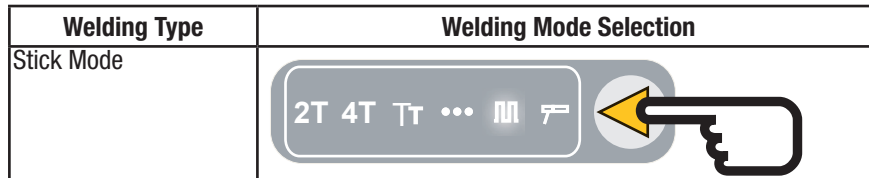
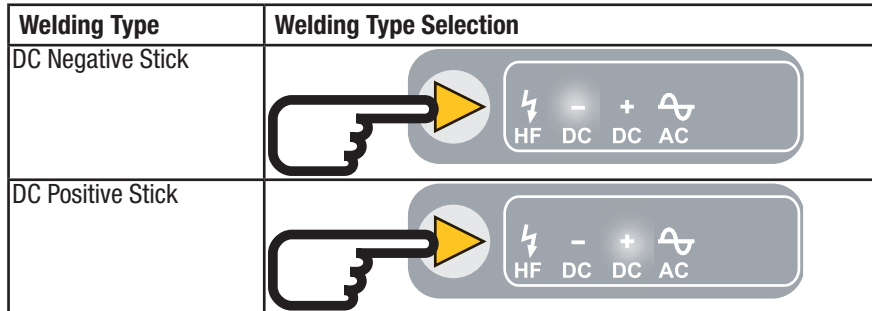

Figure 3-11: Setup for Manual Arc Welding

- First, select Stick Mode by pressing the Welding Mode (10) button.



- Then, select Welding Type by pressing the welding Type (17) button.



3.15 Stick (SMAW) Programming Mode

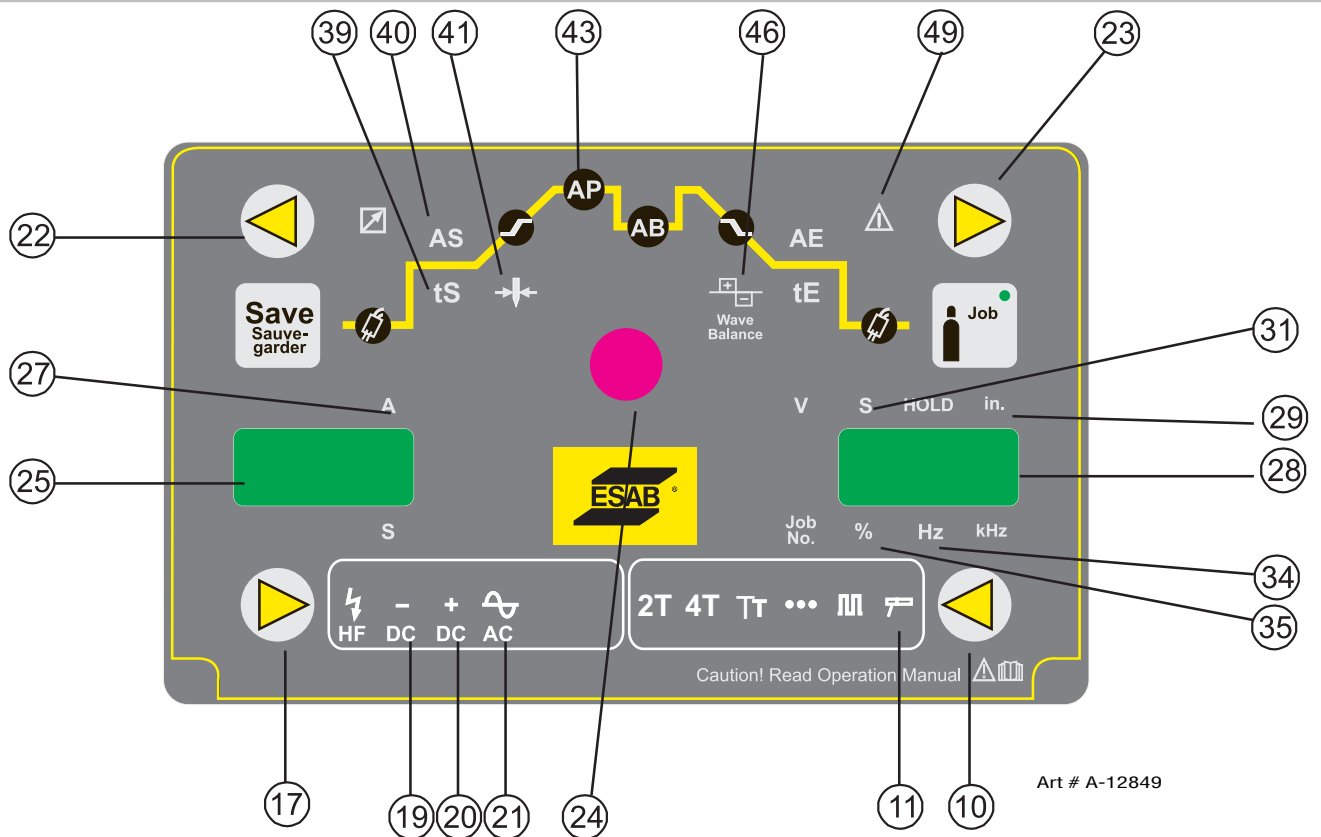

Art # A-12849

Figure 3-12: Stick Programming Mode

- Press the WELDING MODE (10) button to select SMAW mode. The SMAW LED (11) will illuminate.
- Following SMAW operating modes are available.
 - DC Negative mode. DC Negative LED (19) will illuminate.
 - DC Positive mode. DC Positive LED (20) will illuminate.
- Press the BACK button (22) or FORWARD button (23) so the Electrode Diameter LED (41) and Inches LED (29) are illuminated. Use the Multi Function Control (24) to adjust the Electrode size being used.
- Press the BACK button (22) or FORWARD button (23) so the Hot Start Amps LED (40) and % LED (35) are illuminated.

ET 220i AC/DC

Use the Multi Function Control (24) to adjust the Hot Start Amps percentage.

- Press the BACK button (22) or FORWARD button (23) so the Hot Start Time LED (39) and Seconds LED (31) are illuminated.

Use the Multi Function Control (24) to adjust the Hot Start Amps Time.

- Press the BACK button (22) or FORWARD button (23) until the Peak Current LED (43) is illuminated.

Use the Multi Function Control (24) to adjust the Welding Current for the Electrode size being used. If the Welding Current does not match the normal operating range of the electrode the Electrode Diameter Out-of-Range indicator LED (49) will illuminate.

If the Electrode Diameter Out-of-Range indicator LED (49) is illuminated, it is still possible to weld.

SMAW Electrode Diameter (inches)	Nominal Welding Current (A)
1/16" (1.5mm)	20 - 40 Amps
3/32" (2.5mm)	45 - 100 Amps
1/8" (3.2mm)	75 - 140 Amps
5/32" (4.0mm)	130 -190 Amps

Table 3-7: Normal Welding Current for SMAW Electrode sizes







Parameter	Range	LED Code (Left Display)	Parameter Value (Right Display)	Factory Setting
Welding Current A1 ET 220i AC/DC	10 - 170A	A 		100
Electrode Diameter ET 220i AC/DC Set this parameters to the electrode size being used.	1/16" - 5/32"		Inch 	3/32"
Hot Start AS This parameter operates in SMAW mode and is used to improve the start characteristics for stick electrodes by adding current on top of the welding current. e.g. HOT START current = 125 amps when welding current = 100 amps & HOT START = 125%	5 - 200% of Welding Current A1 The maximum welding current in SMAW mode is limited to 170A for the ET 220i AC/DC.	A  When A1=100A		125
Hot Start Time tS This parameter sets the time period for when the Hot Start current is added to the welding current at the start of the weld.	0 - 20 seconds		S 	1.0

Table 3-8: SMAW Main Parameters

Secondary parameters are available. These are required to be set separately.

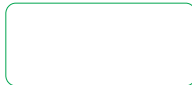
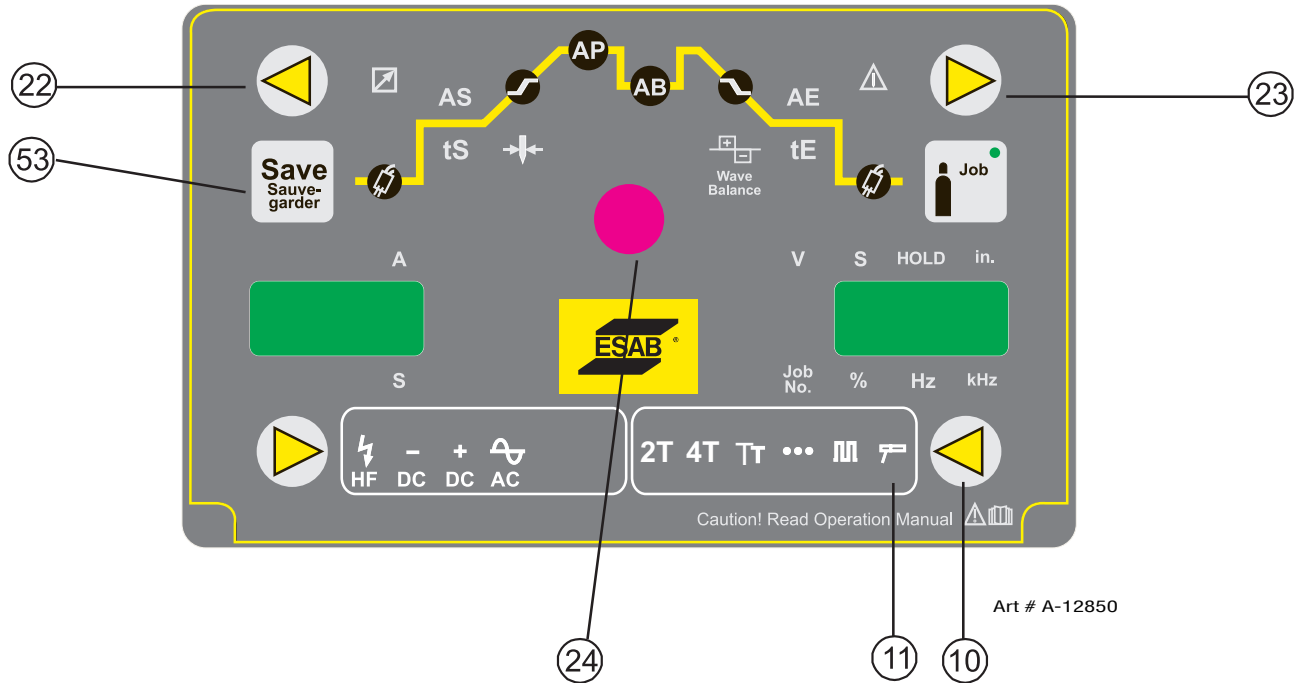

Figure 3-13: Stick Programming Mode

Press and hold the WELDING MODE (10) button then press the SAVE (53) button.

The Arc Dynamic Parameter is selected. In the left hand AMPS display dAr is displayed. In the right hand VOLTS display, the value of the parameter is displayed.

Use the Multi Function Control (24) to adjust the Arc Dynamic parameter.

Press the BACK button (22) or FORWARD button (23) to select the Software Version Number. In the left hand AMPS display rEL is displayed. In the right hand VOLTS display, the Software Version Number is displayed.

Note that even during welding, these settings can be adjusted and changed.



Parameter	Range	LED Code (Left Display)	Parameter Value (Right Display)	Factory Setting
<p>Arc Dynamic (Arc Force)</p> <p>Arc Force is effective in SMAW Mode only. Arc Force control provides an adjustable amount of Arc Force (or "dig"). This feature can be particularly beneficial in providing the operator the ability to compensate for variability in joint fit-up in certain situations with particular electrodes. In general increasing the Arc Force control toward 200% (maximum Arc Force) allows greater penetration control to be achieved.</p>	<p>0 – 200%</p> <p>The welding current increases automatically as the welding voltage is reduced. The Arc Dynamic percentage indicates the ratio between the main current and the automatic increase.</p>			100

Table 3-9: SMAW Secondary Parameters

3.16 User Specific Menus

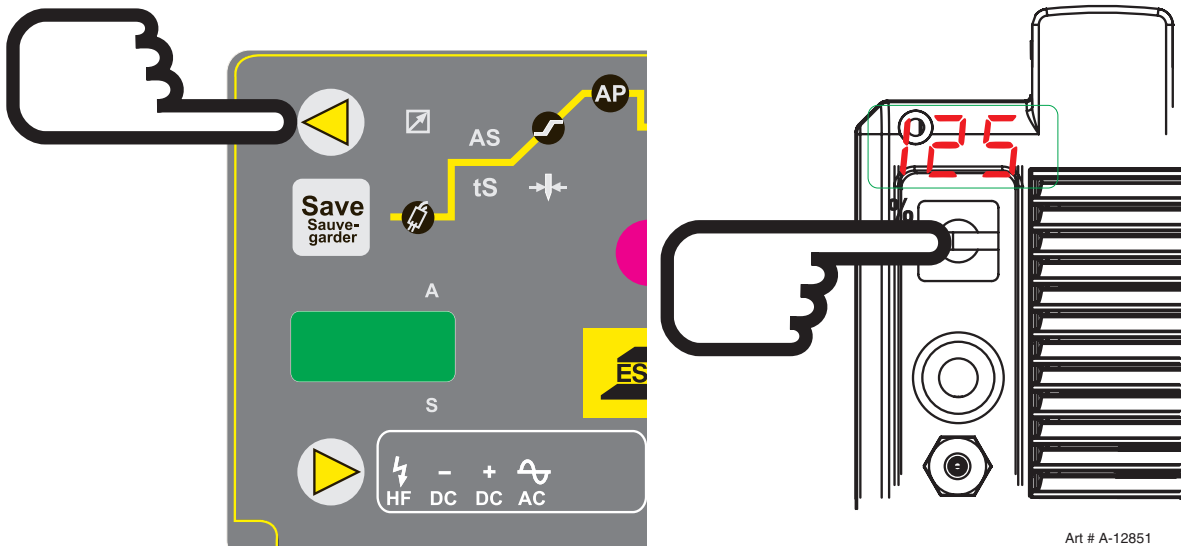

Figure 3-14: User Specific Menus

- Switch off the power to the unit.
Press and hold the BACK Welding Parameter Button (22) .
Switch on the power to the unit.
The User Specific Menus are activated.

After the User Specific Menu items have been set, switch the power off to the unit to save the settings.

Menu item	Range	LED Code (Left Display)	Parameter Value (Right Display)	Factory Setting
<p>C02 – Water Pump Error Message Display Set this to “ON” if a water cooler without a suitable interface lead is being used.</p> <p>Set this to “OFF” if a water cooler with a suitable interface lead is being used.</p>	ON OFF	C02	On	ON
<p>C06 – Downslope Mode When set to “ON” in 4T mode, the downslope will continue even if the trigger is released during the downslope time.</p> <p>When set to “OFF” in 4T mode, the downslope will stop as soon as the trigger is released during the downslope time.</p>	ON OFF	C06	OFF	OFF

Menu item	Range	LED Code (Left Display)	Parameter Value (Right Display)	Factory Setting
<p>C08 – Foot Control Minimum Current (GTAW AC mode only) When set to “ON” the increased Foot Control Minimum current is disabled and the minimum current on any electrode is 5A.</p> <p>When set to “OFF” the increased Foot Control Minimum current is enabled. The minimum currents are: electrode 0.040" – 0.080" (10A) electrode 3/32" (15A) electrode 1/8" (20A)</p>	ON OFF			OFF
<p>C09 (SMAW mode only) Set to “OFF”.</p>	OFF			OFF

Table 3-10: User Specific Menus

3.17 Special Function

Soft Reset

- Press and hold the BACK button (22).
- Press the SAVE button (53).
- All control panel LED's will light up briefly to confirm the Soft Reset has been completed.

NOTE! The only difference between soft & hard reset is that on a hard reset, presets or jobs will be erased. On a soft reset they will remain.

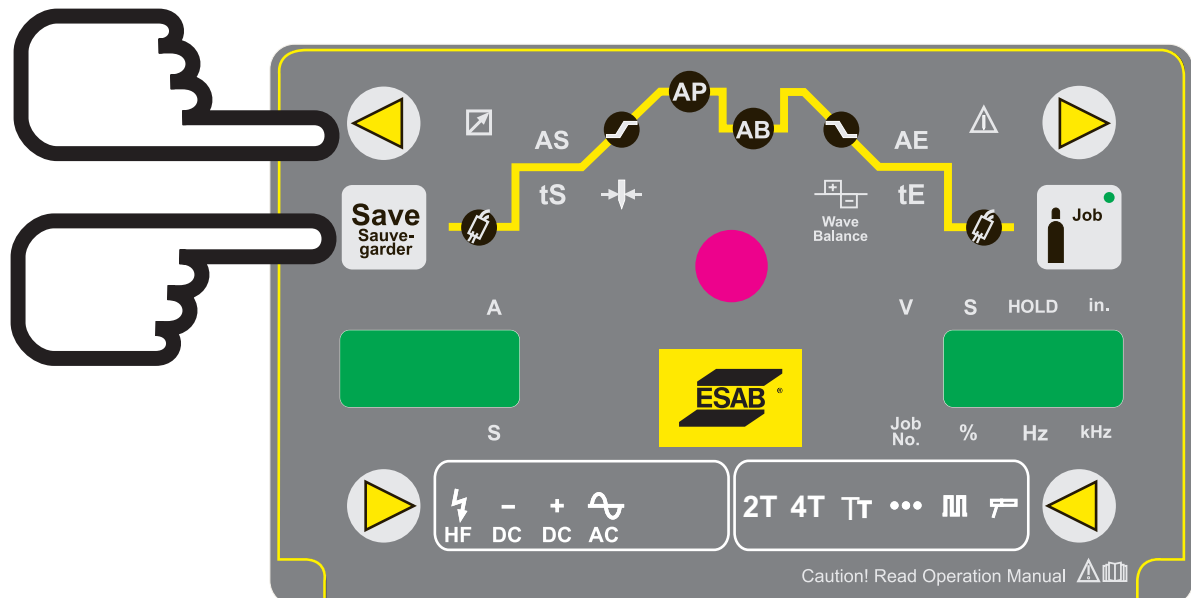

Art # A-12852

Figure 3-15: Soft Reset

ET 220I AC/DC

Master Reset



WARNING

All saved TipTronic jobs will be erased.

All welding and secondary parameters will be restored to the factory setting.

- Press and hold the BACK button (22).
- Press the hold the SAVE button (53).
- All control panel LED's will light up briefly to confirm the Soft Reset has been completed. After 5 seconds all the control panel LED's will light again briefly to confirm the Master Reset has been completed.

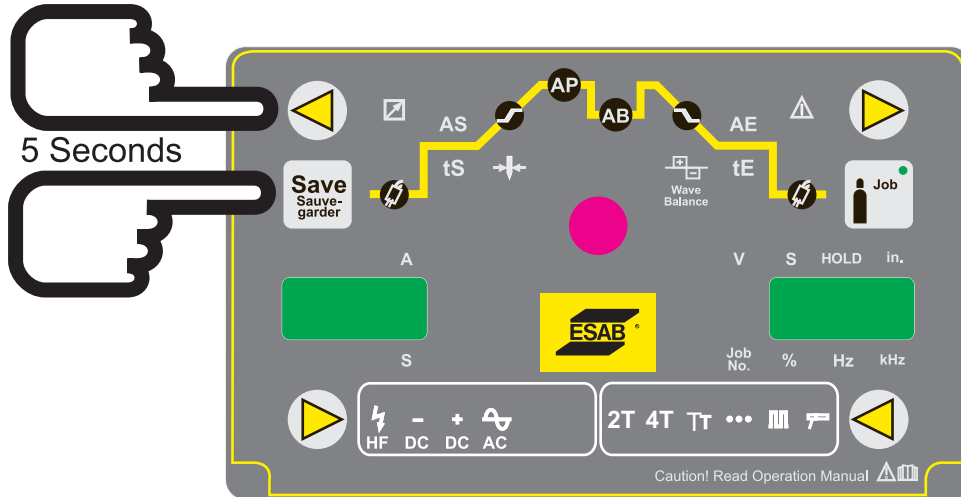

Art # A_12853

Figure 3-16: Master Reset

Control Panel Test

- Press and hold the BACK button (22).
- Press the FORWARD button (23).
- All control panel LED's and meter displays will light up for approximately 4 seconds.

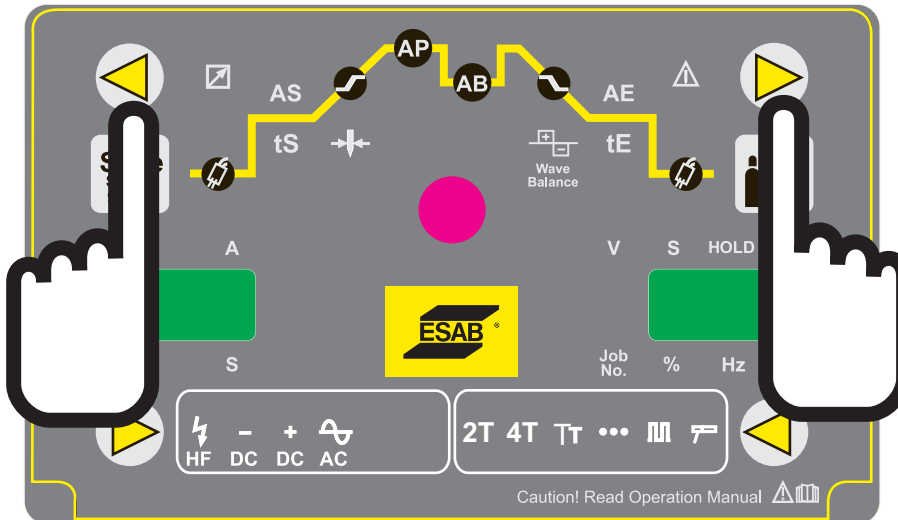

Art # A-12854

Figure 3-17: Control Panel Test

Fan Test

- Press and hold the BACK button (22).
- Press the WELDING TYPE button (17).
- The fan will run for approximately 30 seconds.
- If the BACK button (22) and WELDING TYPE button (17) are pressed again while the fan is running, the fan test is halted.

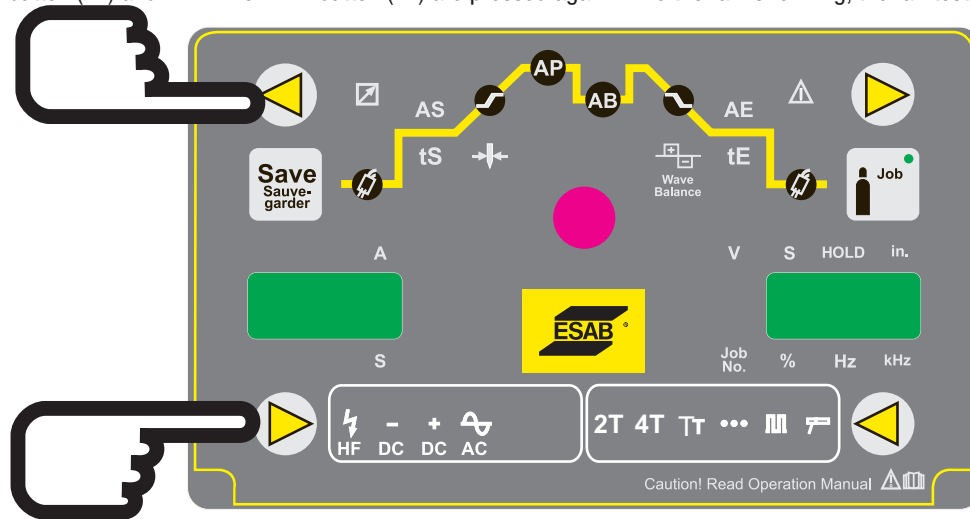

Art # A-12855

Figure 3-18: Fan Test

Water Pump Test

Only for water pump with Net Connection interface

- Press and hold the FORWARD button (22).
- Press the WELDING TYPE button (17).
- The Water Cooler (Net Connection type) will run for approximately 30 seconds.

If there is an error, or no pump is connected, the error message



Will be displayed after approximately 5 seconds.

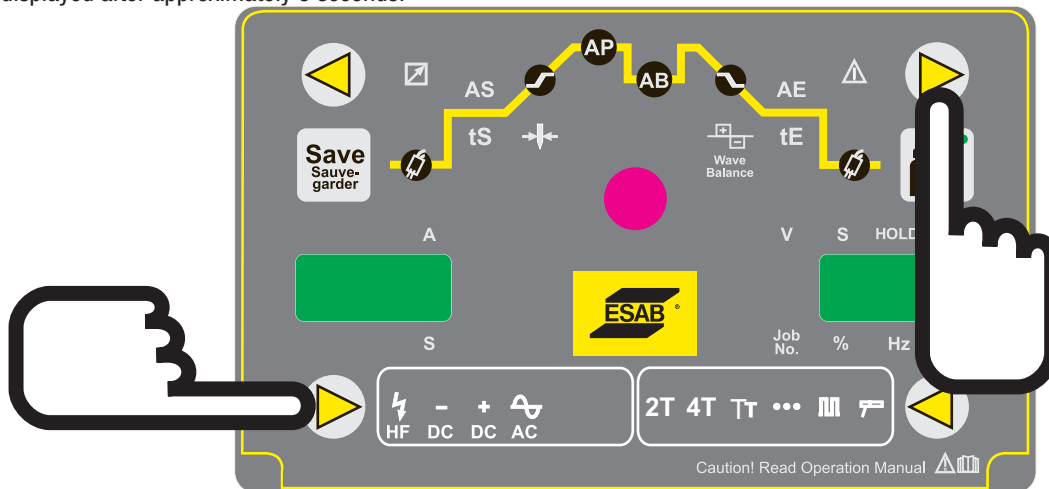

Art # A-12856

Figure 3-19: Water Pump Test

3.18 Shielding Gas Regulator/ Flowmeter Operating Instructions



WARNING

This equipment is designed for use with welding grade (Inert) shielding gases only.

Shielding Gas Regulator/ Flowmeter Safety

This regulator/ flowmeter is designed to reduce and control high pressure gas from a cylinder or pipeline to the working pressure required for the equipment using it.

If the equipment is improperly used, hazardous conditions are created that may cause accidents. It is the users responsibility to prevent such conditions. Before handing or using the equipment, understand and comply at all times with the safe practices prescribed in this instruction.

SPECIFIC PROCEDURES for the use of regulators/ flowmeters are listed below.

1. NEVER subject the regulator/ flowmeter to inlet pressure greater than its rated inlet pressure.
2. NEVER pressurize a regulator/ flowmeter that has loose or damaged parts or is in a questionable condition. NEVER loosen a connection or attempt to remove any part of a regulator/ flowmeter until the gas pressure has been relieved. Under pressure, gas can dangerously propel a loose part.
3. DO NOT remove the regulator/ flowmeter from a cylinder without first closing the cylinder valve and releasing gas in the regulator/ flowmeter high and low pressure chambers.
4. DO NOT use the regulator/ flowmeter as a control valve. When downstream equipment is not in use for extended periods of time, shut off the gas at the cylinder valve and release the gas from the equipment.
5. OPEN the cylinder valve SLOWLY. Close after use.

User Responsibilities

This equipment will perform safely and reliable only when installed, operated and maintained, and repaired in accordance with the instructions provided. Equipment must be checked periodically and repaired, replaced, or reset as necessary for continued safe and reliable performance. Defective equipment should not be used. Parts that are broken, missing, obviously worn, distorted, or contaminated should be replaced immediately.

The user of this equipment will generally have the sole responsibility for any malfunction, which results from improper use, faulty maintenance, or by repair by anyone other than an accredited repairer.



CAUTION

Match regulator/ flowmeter to cylinder. NEVER CONNECT a regulator/ flowmeter designed for a particular gas or gases to a cylinder containing any other gas.

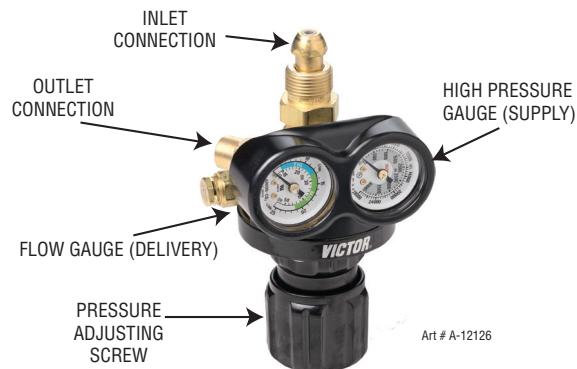

Figure 3-20: Fit Regulator/ Flowmeter to Cylinder



NOTE!

The regulator/ flowmeter used with argon based and carbon dioxide shielding gases are different. The regulator/ flowmeter supplied is for argon based shielding gases. If carbon dioxide is to be used a suitable carbon dioxide regulator/ flowmeter will need to be fitted.

**NOTE!**

All valves downstream of the regulator/ flowmeter must be opened to obtain a true flow rate reading on the outlet gauge. (Welding power source must be triggered) Close the valves after the pressure has been set.

Installation

1. Remove cylinder valve plastic dust seal. Clean the cylinder valve outlet of impurities that may clog orifices and damage seats before connecting the regulator/ flowmeter.
Crack the valve (open then close) momentarily, pointing the outlet away from people and sources of ignition. Wipe with a clean lint free cloth.
2. Match regulator/ flowmeter to cylinder. Before connecting, check that the regulator/ flowmeter label and cylinder marking agree and that the regulator/ flowmeter inlet and cylinder outlet match. NEVER CONNECT a regulator/ flowmeter designed for a particular gas or gases to a cylinder containing any other gas.
3. Connect the regulator/ flowmeter inlet connection to cylinder or pipeline and tighten it firmly but not excessively, with a suitable spanner.
4. Connect and tighten the outlet hose firmly and attach down-stream equipment.
5. To protect sensitive down-stream equipment a separate safety device may be necessary if the regulator/ flowmeter is not fitted with a pressure relief device.

Operation

With the regulator/ flowmeter connected to cylinder or pipeline, and the adjustment screw/knob fully disengaged, pressurize as follows:

1. Stand to one side of regulator/ flowmeter and slowly open the cylinder valve. If opened quickly, a sudden pressure surge may damage internal regulator/ flowmeter parts.
2. With valves on downstream equipment closed, adjust regulator/ flowmeter to approximate working pressure. It is recommended that testing for leaks at the regulator/ flowmeter connection points be carried out using a suitable leak detection solution or soapy water.
3. Purge air or other unwanted welding grade shielding gas from equipment connected to the regulator/ flowmeter by individually opening then closing the equipment control valves. Complete purging may take up to ten seconds or more, depending upon the length and size of the hose being purged.

Adjusting Flow Rate



Figure 3-21: Adjust Flow Rate

With the regulator/ flowmeter ready for operation, adjust working flow rate as follows:

1. Slowly turn adjusting screw/knob in (clockwise) direction until the outlet gauge indicates the required flow rate.

**NOTE!**

It may be necessary to re-check the shielding gas regulator/ flowmeter flow rate following the first weld sequence due to back pressure present within shielding gas hose assembly.

2. To reduce flow rate, allow the welding grade shielding gas to discharge from regulator/ flowmeter by opening the downstream valve. Bleed welding grade shielding gas into a well ventilated area and away from any ignition source. Turn adjusting screw counter clockwise, until the required flow rate is indicated on the gauge. Close downstream valve.

ET 220I AC/DC

Shutdown

Close cylinder valve whenever the regulator/ flowmeter is not in use. To shut down for extended periods (more than 30 minutes).

1. Close cylinder or upstream valve tightly.
2. Open downstream equipment valves to drain the lines. Bleed gas into a well ventilated area and away from any ignition source.
3. After gas is drained completely, disengage adjusting screw and close downstream equipment valves.
4. Before transporting cylinders that are not secured on a cart designed for such purposes, remove regulators/ flowmeters.

3.19 Foot Control, Part No. W4013200 (Optional Accessory)

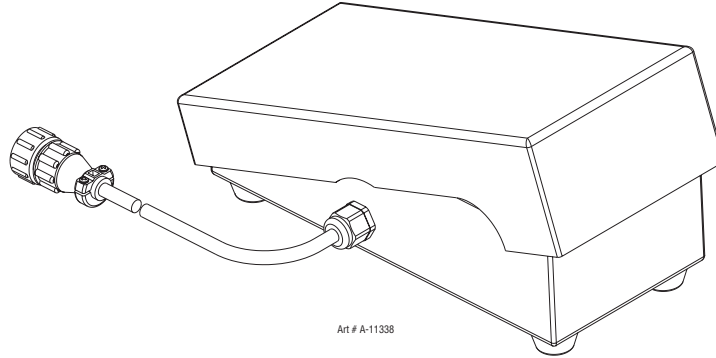

Figure 3-22: Foot Control

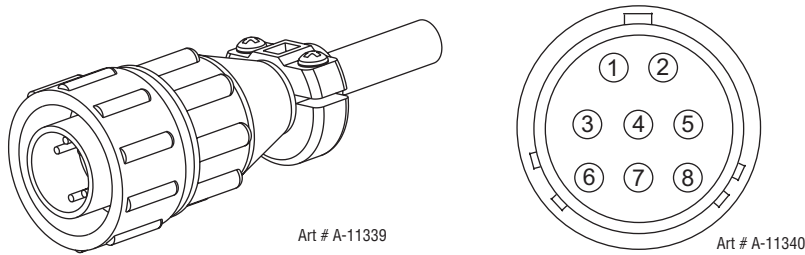

Figure 3-23: 8 Pin Control Plug

Pin	Description
1	Not Used
2	Trigger Switch
3	Trigger Switch
4	Not Used
5	Potentiometer Maximum
6	Potentiometer Minimum
7	Potentiometer Wiper
8	Not Used

Table 3-11: 8 Pin Socket

Description

The Tweco Foot Control is a foot operated switch and potentiometer which starts and stops the welding process and controls welding current through operation of the foot pedal. Refer to list below for compatible Tweco power sources.

Installation

Attach the 8-pin connector on the end of the cable to the 8-pin receptacle on the front of the welding machine. To complete the connection, align the keyway, insert the plug, and rotate the threaded collar fully clockwise.

Foot Control Operation

The foot control listed above Part Number W4013200 foot control will allow you to adjust the maximum output preset amperage. Other 8 pin remote's used with some of our other welders will function as below.

Press the foot pedal to start the machine output functions. The foot control potentiometer controls the welding current up to the level set on the welding power source. Note that the maximum current must be set on the power source by the operator **prior** to the foot control being connected. With the foot control connected, the power source will only display minimum preview Amps until the foot control is depressed then it displays actual welding current when welding. Pressing the pedal to increases the welding current; letting up on the pedal decreases the welding current. Releasing the pedal completely extinguishes the arc and initiates the post-flow shielding gas timer (where fitted).

Note that some power sources may require the remote/local switch set to remote, the maximum setting of the power source will be determined by the respective front panel control, irrespective of the remote control device setting. As an example, if the output current on the power source front panel is set to 50% of the available current and the remote control device is set to 100% output or maximum, the maximum achievable output from the unit will be 50%. Should 100% output be required, the respective front panel control must be set to 100% or maximum, in which case the remote device will then be able to control between 1-100% output.

**NOTE!**

Note 1: Some power sources other than specified as above may not function with the foot control.

Note 2: The foot control will only work correctly when power source trigger mode 2T (Normal) is selected.

This Page Intentionally Blank

SECTION 4: BASIC WELDING GUIDE

4.01 Stick (SMAW) Basic Welding Technique

Size of Electrode

The electrode size is determined by the thickness of metals being joined and can also be governed by the type of welding machine available. Small welding machines will only provide sufficient current (amperage) to run the smaller size electrodes. For thin sections, it is necessary to use smaller electrodes otherwise the arc may burn holes through the job. A little practice will soon establish the most suitable electrode for a given application.

Storage of Electrodes

Always store electrodes in a dry place and in their original containers.

Electrode Polarity

Electrodes are generally connected to the ELECTRODE HOLDER with the Electrode Holder connected positive polarity. The WORK LEAD is connected negative polarity and is connected to the work piece. If in doubt consult the electrode data sheet or your nearest Accredited ESAB Distributor.

Effects of Arc Welding Various Materials

A. High tensile and alloy steels

The two most prominent effects of welding these steels are the formation of a hardened zone in the weld area, and, if suitable precautions are not taken, the occurrence in this zone of under-bead cracks may result. Hardened zone and under-bead cracks in the weld area may be reduced by using the correct electrodes, preheating, using higher current settings, using larger electrodes sizes, short runs for larger electrode deposits or tempering in a furnace.

Hydrogen controlled Electrodes must be used for this application.

B. Austenitic manganese steels

The effect on manganese steel of slow cooling from high temperatures is to embrittle it. For this reason it is absolutely essential to keep manganese steel cool during welding by quenching after each weld or skip welding to distribute the heat.

C. Cast Iron

Most types of cast iron, except white iron, are weldable. White iron, because of its extreme brittleness, generally cracks when attempts are made to weld it. Trouble may also be experienced when welding white-heart malleable, due to the porosity caused by gas held in this type of iron.

D. Copper and alloys

The most important factor is the high rate of heat conductivity of copper, making preheating of heavy sections necessary to give proper fusion of weld and base metal.

Arc Welding Practice

The techniques used for arc welding are almost identical regardless of what types of metals are being joined. Naturally enough, different types of electrodes would be used for different metals as described in the preceding section.

Welding Position

The electrodes dealt with in this publication can be used in most positions, i.e. they are suitable for welding in flat, horizontal, vertical and overhead positions. Numerous applications call for welds to be made in positions intermediate between these. Some of the common types of welds are shown in Figures 4-5 through 4-12.

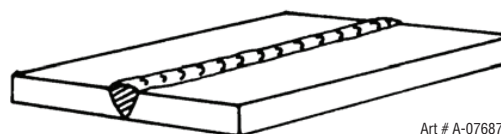

Art # A-07687

Figure 4-1: Flat Position, Down Hand Butt Weld

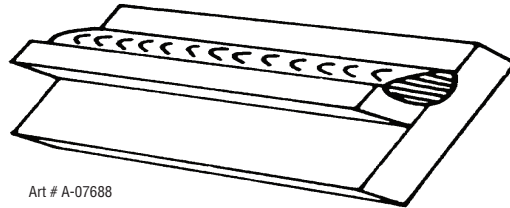

Figure 4-2: Flat Position, Gravity Fillet Weld

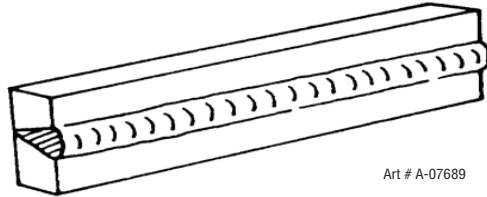

Figure 4-3: Horizontal Position, Butt Weld

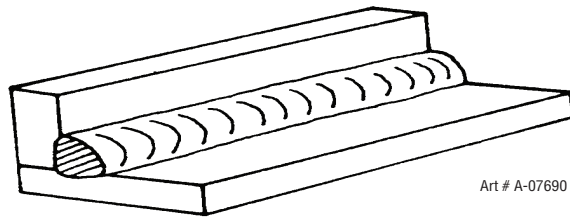

Figure 4-4: Horizontal-Vertical (HV) Position

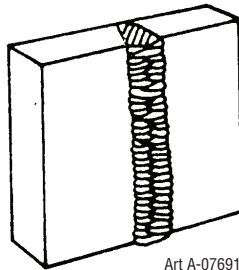

Figure 4-5: Vertical Position, Butt Weld

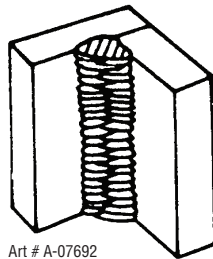

Figure 4-6: Vertical Position, Fillet Weld

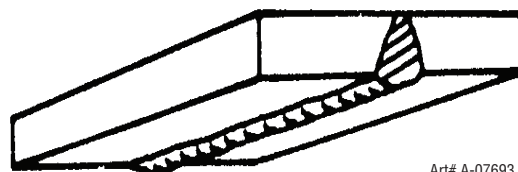

Figure 4-7: Overhead Position, Butt Weld

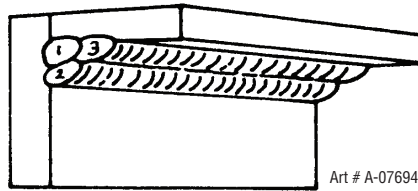

Figure 4-8: Overhead Position, Fillet Weld

Joint Preparations

In many cases, it will be possible to weld steel sections without any special preparation. For heavier sections and for repair work on castings, etc., it will be necessary to cut or grind an angle between the pieces being joined to ensure proper penetration of the weld metal and to produce sound joints.

In general, surfaces being welded should be clean and free of rust, scale, dirt, grease, etc. Slag should be removed from oxy-cut surfaces. Typical joint designs are shown in Figure 4-9.

Open Square Butt Joint

Joint

Gap varies from 1.6mm (1/16") to 4.8mm (3/16") depending on plate thickness

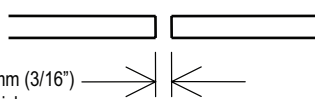

Single Vee Butt Joint

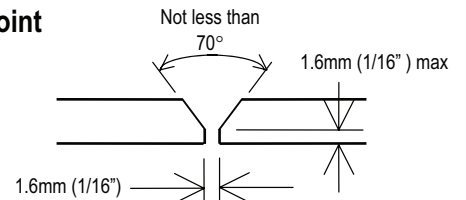

Single Vee Butt Joint

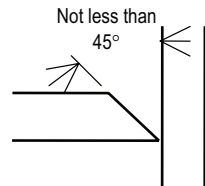

Double Vee Butt Joint

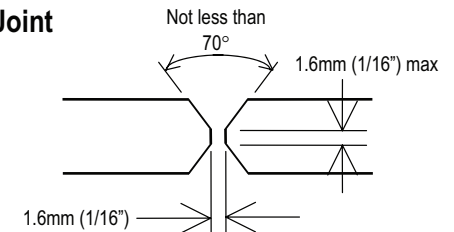

Lap Joint

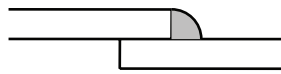

Fillet Joint

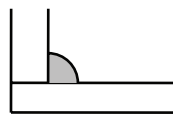

Tee Joints
(Fillet both sides of the joint)

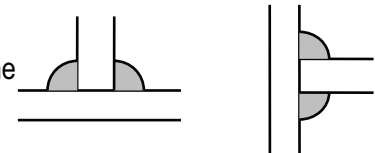

Corner Weld

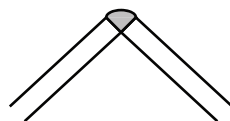

Edge Joint

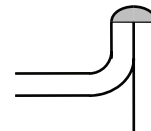

Plug Weld

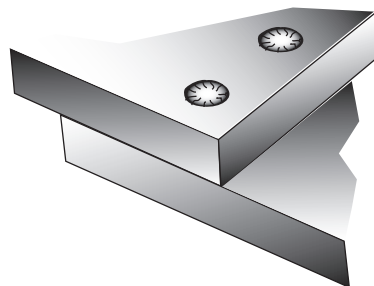

Plug Weld

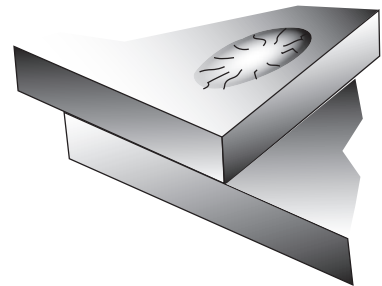

Art # A-07695_AE

Figure 4-9: Typical Joint Designs for Arc Welding

ET 220I AC/DC

Arc Welding Technique - A Word to Beginners

For those who have not yet done any welding, the simplest way to commence is to run beads on a piece of scrap plate. Use mild steel plate about 1/4" thick and a 1/8" electrode. Clean any paint, loose scale or grease off the plate and set it firmly on the work bench so that welding can be carried out in the down-hand position. Make sure that the work clamp is making good electrical contact with the work, either directly or through the work table. For light gauge material, always clamp the work lead directly to the job, otherwise a poor circuit will probably result.

The Welder

Place yourself in a comfortable position before beginning to weld. Get a seat of suitable height and do as much work as possible sitting down. Don't hold your body tense. A taut attitude of mind and a tensed body will soon make you feel tired. Relax and you will find that the job becomes much easier. You can add much to your peace of mind by wearing a leather apron and gauntlets. You won't be worrying then about being burnt or sparks setting alight to your clothes.

Place the work so that the direction of welding is across, rather than to or from, your body. The electrode holder lead should be clear of any obstruction so that you can move your arm freely along as the electrode burns down. If the lead is slung over your shoulder, it allows greater freedom of movement and takes a lot of weight off your hand. Be sure the insulation on your cable and electrode holder is not faulty, otherwise you are risking an electric shock.

Striking the Arc

Practice this on a piece of scrap plate before going on to more exacting work. You may at first experience difficulty due to the tip of the electrode "sticking" to the work piece. This is caused by making too heavy a contact with the work and failing to withdraw the electrode quickly enough. A low amperage will accentuate it. This freezing-on of the tip may be overcome by scratching the electrode along the plate surface in the same way as a match is struck. As soon as the arc is established, maintain a 1/16" to 1/8" gap between the burning electrode end and the parent metal. Draw the electrode slowly along as it melts down. Another difficulty you may meet is the tendency, after the arc is struck, to withdraw the electrode so far that the arc is broken again. A little practice will soon remedy both of these faults.

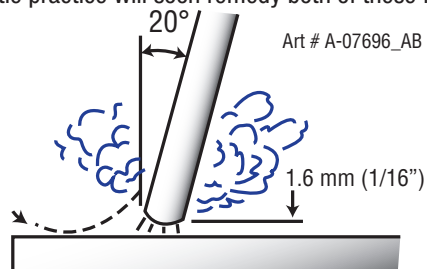

Figure 4-10: Striking an Arc

Arc Length

The securing of an arc length necessary to produce a neat weld soon becomes almost automatic. You will find that a long arc produces more heat. A very long arc produces a crackling or spluttering noise and the weld metal comes across in large, irregular

blobs. The weld bead is flattened and spatter increases. A short arc is essential if a high quality weld is to be obtained although if it is too short there is the danger of it being blanketed by slag and the electrode tip being solidified in. If this should happen, give the electrode a quick twist back over the weld to detach it.

Rate of Travel

After the arc is struck, your next concern is to maintain it, and this requires moving the electrode tip towards the molten pool at the same rate as it is melting away. At the same time, the electrode has to move along the plate to form a bead. The electrode is directed at the weld pool at about 20° from the vertical. The rate of travel has to be adjusted so that a well-formed bead is produced.

If the travel is too fast, the bead will be narrow and strung out and may even be broken up into individual globules. If the travel is too slow, the weld metal piles up and the bead will be too large.

Making Welded Joints

Having attained some skill in the handling of an electrode, you will be ready to go on to make up welded joints.

A. Butt Welds

Set up two plates with their edges parallel, as shown in Figure 4-11, allowing 1/16" to 3/32" gap between them and tack weld at both ends. This is to prevent contraction stresses from the cooling weld metal pulling the plates out of alignment. Plates thicker than 1/4" should have their mating edges bevelled to form a 70° to 90° included angle. This allows full penetration of the weld metal to the root. Using a 1/8" electrode, deposit weld metal on the bottom of the joint.

Do not weave the electrode, but maintain a steady rate of travel along the joint sufficient to produce a well-formed bead. At first you may notice a tendency for undercut to form, but keeping the arc length short, the angle of the electrode at about 20° from vertical, and the rate of travel not too fast, will help eliminate this. The electrode needs to be moved along fast enough to prevent the slag pool from getting ahead of the arc. To complete the joint in thin plate, turn the job over, clean the slag out of the back and deposit a similar weld.

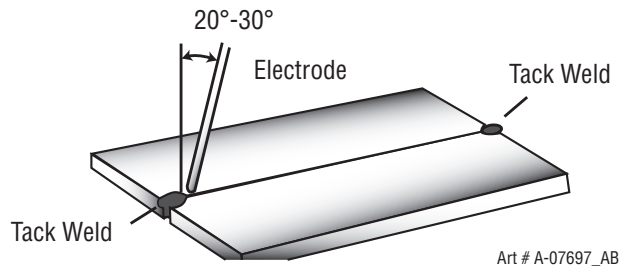

Figure 4-11: Butt Weld

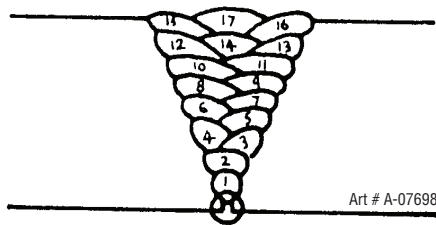

Figure 4-12: Weld Build up Sequence

Heavy plate will require several runs to complete the joint. After completing the first run, chip the slag out and clean the weld with a wire brush. It is important to do this to prevent slag being trapped by the second run. Subsequent runs are then deposited using either a weave technique or single beads laid down in the sequence shown in Figure 4-12. The width of weave should not be more than three times the core wire diameter of the electrode. When the joint is completely filled, the back is either machined, ground or gouged out to remove slag which may be trapped in the root, and to prepare a suitable joint for depositing the backing run. If a backing bar is used, it is not usually necessary to remove this, since it serves a similar purpose to the backing run in securing proper fusion at the root of the weld.

B. Fillet Welds

These are welds of approximately triangular cross-section made by depositing metal in the corner of two faces meeting at right angles. Refer to Figure 4-4.

A piece of angle iron is a suitable specimen with which to begin, or two lengths of strip steel may be tacked together at right angles. Using a 1/8" electrode, position angle iron with one leg horizontal and the other vertical. This is known as a horizontal-vertical (HV) fillet. Strike the arc and immediately bring the electrode to a position perpendicular to the line of the fillet and about 45° from the vertical. Some electrodes require to be sloped about 20° away from the perpendicular position to prevent slag from running ahead of the weld. Refer to Figure 4-13. Do not attempt to build up much larger than 1/4" width with a 1/8" electrode, otherwise the weld metal tends to sag towards the base, and undercut forms on the vertical leg. Multi-runs can be made as shown in Figure 4-14. Weaving in HV fillet welds is undesirable.

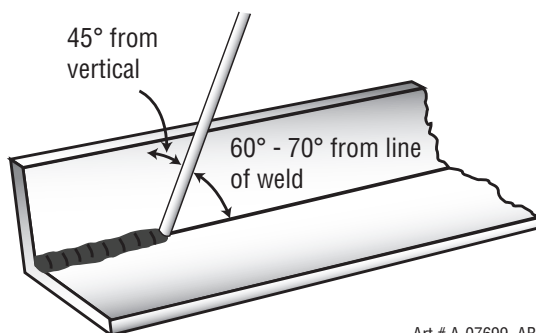

Figure 4-13: Electrode Position for HV Fillet Weld

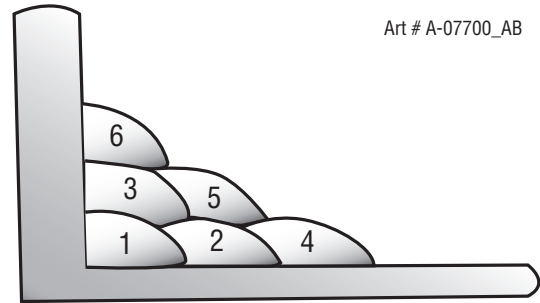

Figure 4-14: Multi-runs in HV Fillet Weld

C. Vertical Welds

1. Vertical Up

Tack weld a three feet length of angle iron to your work bench in an upright position. Use a 1/8" electrode. Make yourself comfortable on a seat in front of the job and strike the arc in the corner of the fillet. The electrode needs to be about 10° from the horizontal to enable a good bead to be deposited. Refer Figure 4-15. Use a short arc, and do not attempt to weave on the first run. When the first run has been completed de-slag the weld deposit and begin the second run at the bottom. This time a slight weaving motion is necessary to cover the first run and obtain good fusion at the edges. At the completion of each side motion, pause for a moment to allow weld metal to build up at the edges, otherwise undercut will form and too much metal will accumulate in the centre of the weld. Figure 4-16 illustrates multi-run technique and Figure 4-17 shows the effects of pausing at the edge of weave and of weaving too rapidly.

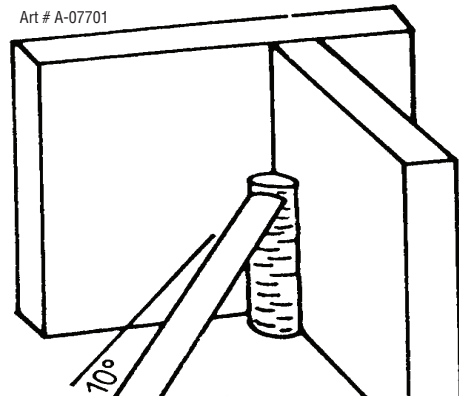

Figure 4-15: Single Run Vertical Fillet Weld

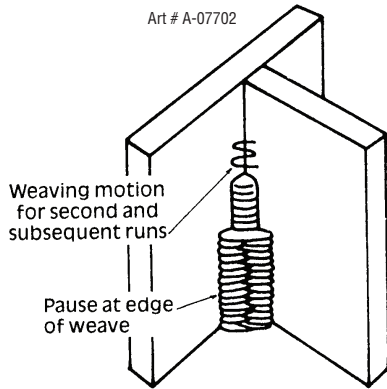

Figure 4-16: Multi Run Vertical Fillet Weld

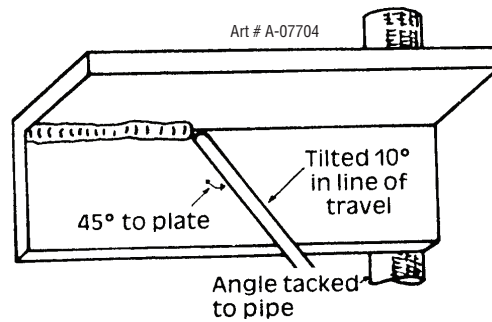

Figure 4-18: Overhead Fillet Weld

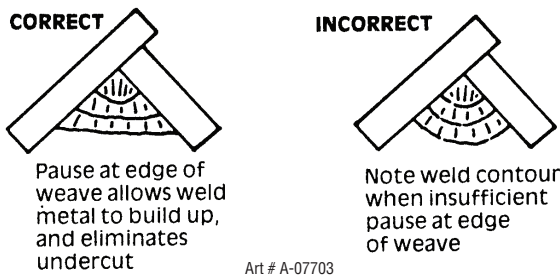

Figure 4-17: Examples of Vertical Fillet Welds

2. Vertical Down

Use an 1/8" electrode. The tip of the electrode is held in light contact with the work and the speed of downward travel is regulated so that the tip of the electrode just keeps ahead of the slag. The electrode should point upwards at an angle of about 45°.

3. Overhead Welds

Apart from the rather awkward position necessary, overhead welding is not much more difficult than downhand welding. Set up a specimen for overhead welding by first tacking a length of angle iron at right angles to another piece of angle iron or a length of waste pipe. Then tack this to the work bench or hold in a vice so that the specimen is positioned in the overhead position as shown in the sketch. The electrode is held at 45° to the horizontal and tilted 10° in the line of travel (Figure 4-18). The tip of the electrode may be touched lightly on the metal, which helps to give a steady run. A weave technique is not advisable for overhead fillet welds. Deposit the first run by simply drawing the electrode along at a steady rate. You will notice that the weld deposit is rather convex, due to the effect of gravity before the metal freezes.

Distortion

Distortion in some degree is present in all forms of welding. In many cases it is so small that it is barely perceptible, but in other cases allowance has to be made before welding commences for the distortion that will subsequently occur. The study of distortion is so complex that only a brief outline can be attempted here.

The Cause of Distortion

Distortion is caused by:

A. Contraction of Weld Metal:

Molten steel shrinks approximately 11 per cent in volume on cooling to room temperature. This means that a cube of molten metal would contract approximately 2.2 per cent in each of its three dimensions. In a welded joint, the metal becomes attached to the side of the joint and cannot contract freely. Therefore, cooling causes the weld metal to flow plastically, that is, the weld itself has to stretch if it is to overcome the effect of shrinking volume and still be attached to the edge of the joint. If the restraint is very great, as, for example, in a heavy section of plate, the weld metal may crack. Even in cases where the weld metal does not crack, there will still remain stresses "Locked-up" in the structure. If the joint material is relatively weak, for example, a butt joint in thin sheet, the contracting weld metal may cause the sheet to become distorted.

B. Expansion and Contraction of Parent Metal in the Fusion Zone:

While welding is proceeding, a relatively small volume of the adjacent plate material is heated to a very high temperature and attempts to expand in all directions. It is able to do this freely at right angles to the surface of the plate (i.e., "through the weld", but when it attempts to expand "across the weld" or "along the weld", it meets considerable resistance, and to fulfill the desire for continued expansion, it has to deform plastically, that is, the metal adjacent to the weld is at a high temperature and hence rather soft, and, by expanding, pushes against the cooler, harder metal further away, and tends to bulge (or is "upset"). When the weld area begins to cool, the "upset" metal attempts to contract as much as it expanded, but, because it has been "upset" it does not resume its former shape, and the contraction of the new shape exerts a strong pull on adjacent metal. Several things can then happen.

The metal in the weld area is stretched (plastic deformation), the job may be pulled out of shape by the powerful contraction

stresses (distortion), or the weld may crack, in any case, there will remain "locked-up" stresses in the job. Figures 4-19 and 4- 20 illustrate how distortion is created.

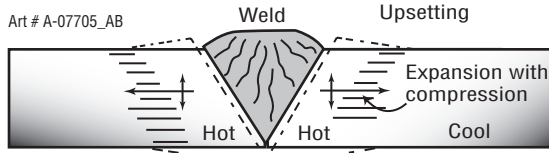

Figure 4-19: Parent Metal Expansion

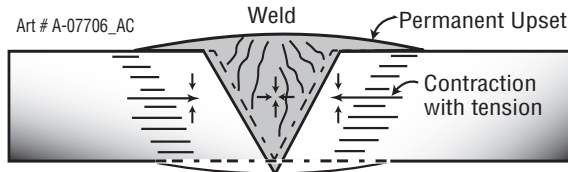

Figure 4-20: Parent Metal Contraction

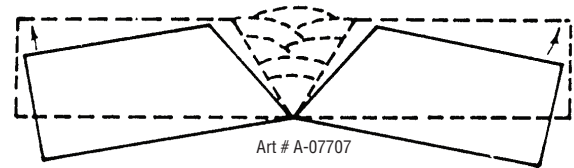
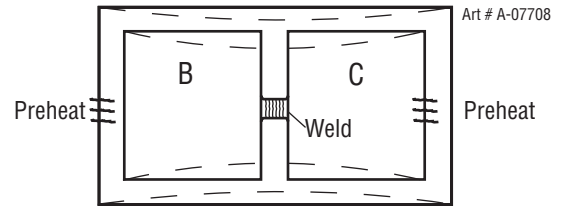

Figure 4-21: Principle of Presetting



Dotted lines show effect if no preheat is used

Figure 4-22: Reduction of Distortion by Preheating

Overcoming Distortion Effects

There are several methods of minimizing distortion effects.

A. Peening

This is done by hammering the weld while it is still hot. The weld metal is flattened slightly and because of this the tensile stresses are reduced a little. The effect of peening is relatively shallow, and is not advisable on the last layer.

B. Distribution of Stresses

Distortion may be reduced by selecting a welding sequence which will distribute the stresses suitably so that they tend to cancel each other out. See Figures 4-20 through 4-23 for various weld sequences. Choice of a suitable weld sequence is probably the most effective method of overcoming distortion, although an unsuitable sequence may exaggerate it. Simultaneous welding of both sides of a joint by two welders is often successful in eliminating distortion.

C. Restraint of Parts

Forcible restraint of the components being welded is often used to prevent distortion. Jigs, positions, and tack welds are methods employed with this in view.

D. Presetting

It is possible in some cases to tell from past experience or to find by trial and error (or less frequently, to calculate) how much distortion will take place in a given welded structure. By correct pre-setting of the components to be welded, constructional stresses can be made to pull the parts into correct alignment. A simple example is shown in Figure 4-21.

E. Preheating

Suitable preheating of parts of the structure other than the area to be welded can be sometimes used to reduce distortion. Figure 4-22 shows a simple application. By removing the heating source from b and c as soon as welding is completed, the sections b and c will contract at a similar rate, thus reducing distortion.

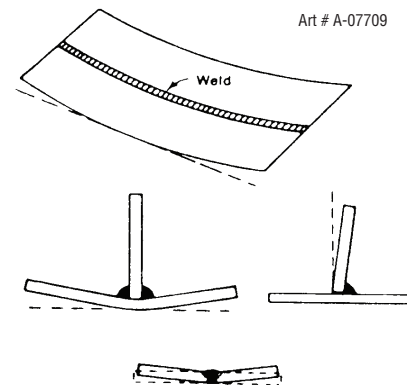
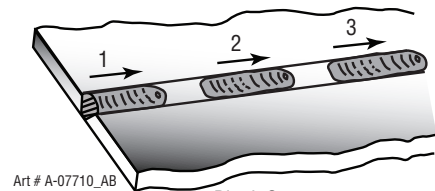

Figure 4-23: Examples of Distortion



Block Sequence.
The spaces between the welds are filled in when the welds are cool.

Figure 4-24: Welding Sequence

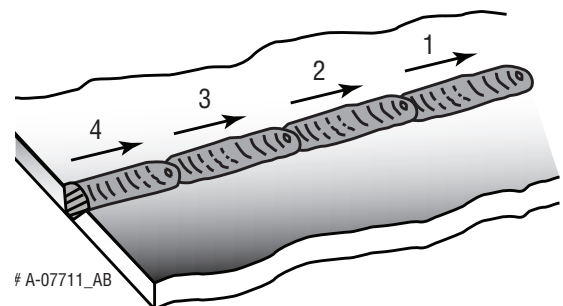
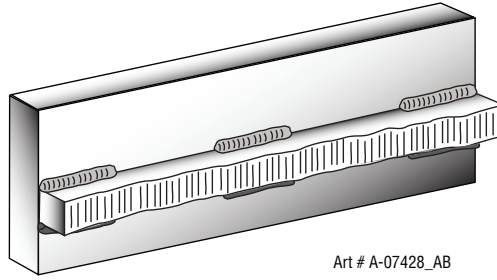
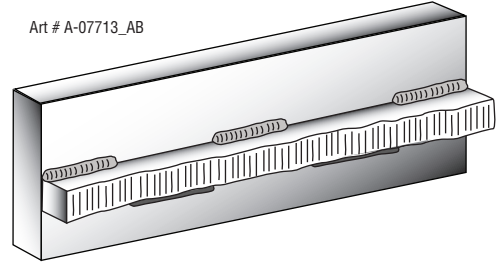

Figure 4-25: Step back Sequence



Art # A-07428_AB

Figure 4-26: Chain Intermittent Welding



Art # A-07713_AB

Figure 4-27: Staggered Intermittent Welding

4.02 Stick (SMAW) Welding Troubleshooting

FAULT	CAUSE	REMEDY
1 Welding current varying	ARC FORCE parameter is set at a value that causes the welding current to vary excessively with the arc length.	Reduce the ARC FORCE parameter until welding current is reasonably constant while prohibiting the electrode from sticking to the work piece when you “dig” the electrode into the workpiece.
2 A gap is left by failure of the weld metal to fill the root of the weld.	A Welding current too low B Electrode too large for joint. C Insufficient gap.	A Increase welding current. B Use smaller diameter electrode. C Allow wider gap.
3 Non-metallic particles are trapped in the weld metal.	A Non-metallic particles may be trapped in undercut from previous run. B Joint preparation too restricted. C Irregular deposits allow slag to be trapped. D Lack of penetration with slag trapped beneath weld bead. E Rust or mill scale is preventing full fusion. F Wrong electrode for position in which welding is done.	A If a bad undercut is present clean slag bout and cover with a run from a smaller gauge electrode. B Allow for adequate penetration and room for cleaning out the slag. C If very bad, chip or grind out irregularities. D Use smaller electrode with sufficient current to give adequate penetration. Use suitable tools to remove all slag from comers. E Clean joint before welding. F Use electrodes designed for position in which welding is done, otherwise proper control of slag is difficult.

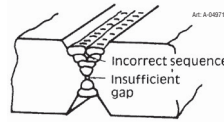

Figure 1: Example of insufficient gap or incorrect sequence

<p>4 A groove has been formed in the base metal adjacent to the toe of a weld and has not been filled by the weld metal (undercut).</p>	<p>A Welding current is too high. B Welding arc is too long. C Angle of the electrode is incorrect. D Joint preparation does not allow correct electrode angle. E Electrode too large for joint. F Insufficient deposit time at edge of weave.</p>	<p>A Reduce welding current. B Reduce the length of the welding arc. C Electrode should not be inclined less than 45° to the vertical face. D Allow more room in joint for manipulation of the electrode. E Use smaller gauge electrode. F Pause for a moment at edge of weave to allow weld metal buildup.</p>
<p>5 Portions of the weld run do not fuse to the surface of the metal or edge of the joint.</p>	<p>A Small electrodes used on heavy cold plate. B Welding current is too low. C Wrong electrode angle. D Travel speed of electrode is too high. E Scale or dirt on joint surface.</p>	<p>A Use larger electrodes and preheat the plate. B Increase welding current. C Adjust angle so the welding arc is directed more into the base metal. D Reduce travel speed of electrode. E Clean surface before welding.</p>

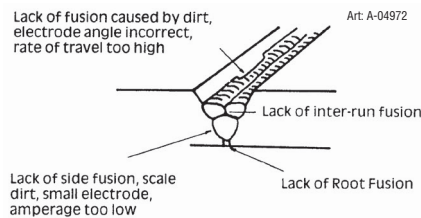

Figure 2: Example of Lack of Fusion

ET 220I AC/DC

<p>6 Gas pockets or voids in weld metal (porosity)</p>	<p>A High levels of sulphur in steel. B Electrodes are damp. C Welding current is too high. D Surface impurities such as oil, grease, paint, etc. E Welding in a windy environment. F Electrode damaged ie flux coating incomplete.</p>	<p>A Use an electrode that is designed for high sulphur steels. B Dry electrodes before use. C Reduce welding current. D Clean joint before welding. E Shield the weld area from the wind. F Discard damaged electrodes and only use electrodes with a complete flux coating.</p>
<p>7 Crack occurring in weld metal soon after solidification commences</p>	<p>A Rigidity of joint. B Insufficient throat thickness. C Weld current is too high.</p>	<p>A Redesign to relieve weld joint of severe stresses or use crack resistance electrodes. B Travel slightly slower to allow greater build up in throat. C Decrease welding current.</p>

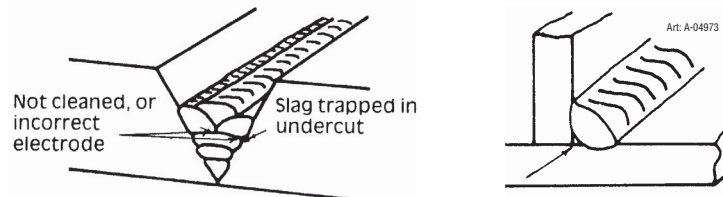

Figure 3: Example of Slag Inclusion

Table 4-1: Welding Problems SMAW (Stick)

4.03 TIG (GTAW) Basic Welding Technique

Gas Tungsten Arc Welding (GTAW) or TIG (Tungsten Inert Gas) as it is commonly referred to, is a welding process in which fusion is produced by an electric arc that is established between a single tungsten (non-consumable) electrode and the work piece. Shielding is obtained from a welding grade shielding gas or welding grade shielding gas mixture which is generally Argon based. A filler metal may also be added manually in some circumstances depending on the welding application.

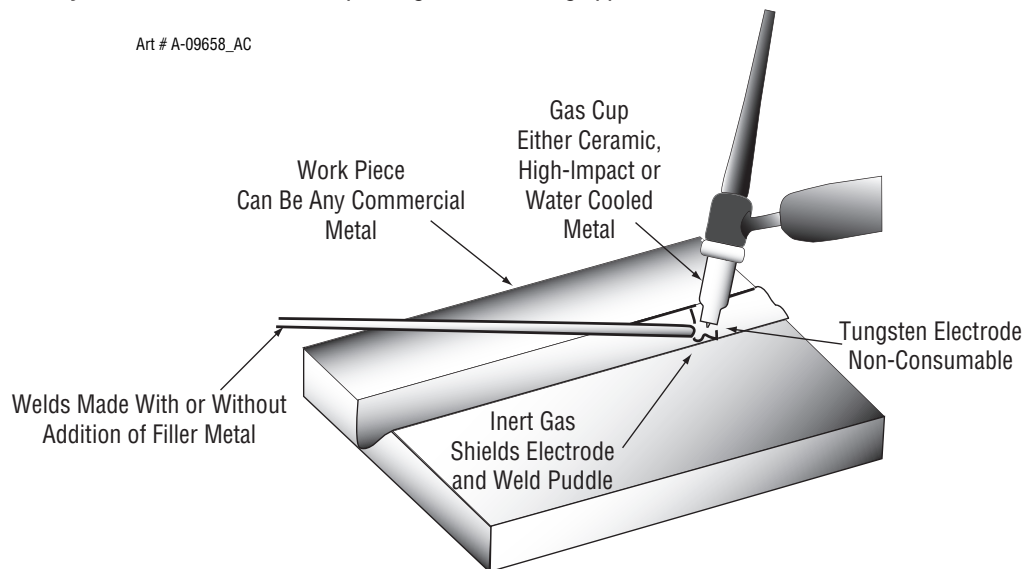

Figure 4-28: TIG Welding Application Shot

Tungsten Electrode Current Ranges

Electrode Diameter	DC Current (Amps)
0.040" (1.0mm)	30-60
1/16" (1.6mm)	60-115
3/32" (2.4mm)	100-165
1/8" (3.2mm)	135-200
5/32" (4.0mm)	190-280
3/16" (4.8mm)	250-340

Table 4-2: Current Ranges for Various Tungsten Electrode Sizes

Guide for Selecting Filler Wire Diameter

Filler Wire Diameter	DC Current Range (Amps)
1/16" (1.6mm)	20-90
3/32" (2.4mm)	65-115
1/8" (3.2mm)	100-165
3/16" (4.8mm)	200-350

Table 4-3: Filler Wire Selection Guide

ET 220I AC/DC

Tungsten Electrode Types

Electrode Type (Ground Finish)	Welding Application	Features	Colour Code
Thoriated 2%	DC welding of mild steel, stainless steel and copper	Excellent arc starting, Long life, High current carrying capacity	Red
Zirconated 1%	High quality AC welding of aluminium, magnesium and their alloys.	Self cleaning, Long life, Maintains balled end, High current carrying capacity.	White
Ceriated 2%	AC & DC welding of mild steel, stainless steel, copper, aluminium, magnesium and their alloys	Longer life, More stable arc, Easier starting, Wider current range, Narrower more concentrated arc.	Grey

Table 4-4: Tungsten Electrode Types

TIG Welding Filler Rods

AWS Std	Type/Application
ER70S-4 ER70S-6 ER70S-2	For mild-medium strength steels. Pipes, tubing, roll cages, etc.
ER80S-B2 ER90S-B3	For welding of high strength Cr-Mo steels used at elevated temperatures.
ER308L ER309L ER316L	For stainless steels. Stainless pipes, tubing, architectural uses, etc.
R4043	For stainless steels. Stainless pipes, tubing, architectural uses, etc.
R5356	For cast and wrought aluminium alloys.

Table 4-5: TIG Welding Filler Rods

Base Metal Thickness	DC Current for Mild Steel	DC Current for Stainless Steel	Tungsten Electrode Diameter	Filler Rod Diameter (if required)	Argon Gas Flow Rate Litres/min	Joint Type
0.040" 1.0mm	35-45 40-50	20-30 25-35	0.040" 1.0mm	1/16" 1.6mm	5-7	Butt/Corner Lap/Fillet
0.045" 1.2mm	45-55 50-60	30-45 35-50	0.040" 1.0mm	1/16" 1.6mm	5-7	Butt/Corner Lap/Fillet
1/16" 1.6mm	60-70 70-90	40-60 50-70	1/16" 1.6mm	1/16" 1.6mm	7	Butt/Corner Lap/Fillet
1/8" 3.2mm	80-100 90-115	65-85 90-110	1/16" 1.6mm	3/32" 2.4mm	7	Butt/Corner Lap/Fillet
3/16" 4.8mm	115-135 140-165	100-125 125-150	3/32" 2.4mm	1/8" 3.2mm	10	Butt/Corner Lap/Fillet
1/4" 6.4mm	160-175 170-200	135-160 160-180	1/8" 3.2mm	5/32" 4.0mm	10	Butt/Corner Lap/Fillet

Table 4-6: Welding Rate

TIG Welding is generally regarded as a specialised process that requires operator competency. While many of the principles outlined in the previous Arc Welding section are applicable a comprehensive outline of the TIG Welding process is outside the scope of this Operating Manual. For further information please refer to www.esab.com or contact ESAB.

4.04 TIG (GTAW) Welding Problems

FAULT	CAUSE	REMEDY
1 Excessive bead build up or poor penetration or poor fusion at edges of weld.	Welding current is too low	Increase weld current and/or faulty joint preparation.
2 Weld bead too wide and flat or undercut at edges of weld or excessive burn through.	Welding current is too high	Decrease weld current.
3 Weld bead too small or insufficient penetration or ripples in bead are widely spaced apart.	Travel speed too fast	Reduce travel speed.
4 Weld bead too wide or excessive bead build up or excessive penetration in butt joint.	Travel speed too slow	Increase travel speed.
5 Uneven leg length in fillet joint	Wrong placement of filler rod	Re-position filler rod.
6 Electrode melts or oxidises when an arc is struck.	A Torch lead connected to positive welding terminal. B No gas flowing to welding region. C Torch is clogged with dust or dirt. D Gas hose is cut. E Gas passage contains impurities. F Gas regulator turned off. G The electrode is too small for the welding current. H Power source is set for Stick welding.	A Connect torch lead to negative welding terminal. B Check the gas lines for kinks or breaks and gas cylinder contents. C Clean torch. D Replace gas hose. E Disconnect gas hose from the rear of Power Source then raise gas pressure and blow out impurities. F Turn on. G Increase electrode diameter or reduce the welding current. H Set Power Source to a GTAW operating mode.

FAULT	CAUSE	REMEDY
7 Dirty weld pool	<p>A Electrode contaminated by contact with work piece or filler rod material.</p> <p>B Work piece surface has foreign material on it.</p> <p>C Gas contaminated with air.</p>	<p>A Clean the electrode by grinding off the contaminates.</p> <p>B Clean surface.</p> <p>C Check gas lines for cuts and loose fitting or change gas cylinder.</p>
8 Poor weld finish	Inadequate shielding gas.	Increase gas flow or check gas line for gas flow problems.
9 Arc start is not smooth.	<p>A Tungsten electrode is too large for the welding current.</p> <p>B The wrong electrode is being used for the welding job.</p> <p>C Gas flow rate is too high.</p> <p>D Incorrect shielding gas is being used.</p> <p>E Poor work clamp connection to work piece.</p>	<p>A Select the right size tungsten electrode. Refer to Table 4-3 ESAB Tungsten Electrode Selection Chart.</p> <p>B Select the right tungsten electrode type. Refer to Table 4-5 ESAB Tungsten Electrode Selection Chart.</p> <p>C Select the right rate for the welding job. Refer to Table 4-7.</p> <p>D Select the right shielding gas.</p> <p>E Improve connection to work piece.</p>
10 Arc flutters during TIG welding.	Tungsten electrode is too large for the welding current.	Select the right size tungsten electrode. Refer to Table 4-3 ESAB Tungsten Electrode Selection Chart.

Table 4-7

SECTION 5: POWER SOURCE PROBLEMS AND ROUTINE SERVICE REQUIREMENTS

5.01 Basic Troubleshooting

WARNING

There are extremely dangerous voltage and power levels present inside this product. Do not attempt to open or repair unless you are a qualified electrical tradesperson and you have had training in power measurements and troubleshooting techniques..

If major complex subassemblies are faulty, then the Welding Power Source must be returned to an accredited ESAB Service Provider for repair. The basic level of troubleshooting is that which can be performed without special equipment or knowledge. Refer also to section 4 for solving welding problems.

Information Messages

If a message has been displayed, the power source may only function to a limited capacity. The cause of the condition must be remedied as soon as possible.

Message Code	Note	Cause	Possible Remedy
	Mains Supply Under Voltage	Mains Supply Voltage is too low	Check Mains Supply Voltage
	Fans	Fan Fault	Have an Accredited ESAB Service Provider check the power source.
	EEProm checksum error	Communication with EEPROM is faulty	Switch machine off, then back on. Perform a master reset. If the problem continues have an Accredited ESAB Service Provider check the power source.
	EEProm read / write error	Communication with EEPROM is faulty	Switch machine off, then back on. Perform a master reset. If the problem continues have an Accredited ESAB Service Provider check the power source.
No Display	The fuse protects the small control transformer that produces the internal supply for the PCBs. A blown fuse might be the result of turning the on-off switch to often in a very short time. DO NOT flip the on-off switch more than two times within a one second period. This may result in no display on the machine even while turned on.	Turning the machine off too many times in a short period.	Turn the machine OFF for two minutes then switch ON again. If still no display shows it is likely the fuse is blown and needs to be replaced. The fuse on the relay board is a 2.5A/500V (slow blowing) 6.3mm x 32mm. Note: When switching the machine off and on again, wait 2-3 seconds between each switch. For example switch off, wait 3 seconds, switch on again.

Table 5-1: Information Messages

ET 220I AC/DC

Error Messages

If a message has been displayed, have an Accredited ESAB Service Provider check the power source.

Message Code	Error	Cause	Possible Remedy
E01 -01	Thermal Overload of Output Diodes	Duty Cycle has been exceeded	Leave the power source switched ON and allow it to cool.
E01 -02	Thermal Overload of Primary Module	Duty Cycle has been exceeded	Leave the power source switched ON and allow it to cool.
E01 -03	Thermal Overload of Transformer	Duty Cycle has been exceeded	Leave the power source switched ON and allow it to cool.
E02 -00	Mains Supply Over Voltage	Mains Supply Voltage is too high	Check Mains Supply Voltage
E05 -00	Water Pump (in water cooled operation) Torch Monitor (in gas cooled operation)	Defective connection cable or water cooler Water cooled GTAW torch connected	Check the Net Connection water cooler cable and the water cooler. Use a gas cooled torch
E06 -00	Secondary Over Voltage	Initial Voltage is too high	Have an Accredited ESAB Service Provider check the power source
E09 -00	Voltage Detection	Voltage Detection Error	Have an Accredited ESAB Service Provider check the power source
E09 -01	Voltage Detection plug socket	Voltage Detection Error in module 2	Have an Accredited ESAB Service Provider check the power source
E10 -00	Torch / Remote Control	Remote Control, Torch or connections defective	Check or replace Torch or Remote Control
E12 -00	Power Section Fault	Power Section start up Fault	Have an Accredited ESAB Service Provider check the power source
E13 -01	Temperature Sensor Secondary Diode	Defective Thermal Sensor	Have an Accredited ESAB Service Provider check the power source
E13 -02	Temperature Sensor Primary Module	Defective Thermal Sensor	Have an Accredited ESAB Service Provider check the power source
E13 -03	Temperature Sensor Transformer	Defective Thermal Sensor	Have an Accredited ESAB Service Provider check the power source
E14 -00	Internal Supply Voltage	Internal Supply Voltage Fault	Have an Accredited ESAB Service Provider check the power source
E15 -00	Current Detection	Current Detection Fault	Have an Accredited ESAB Service Provider check the power source
E16 -00	Shutdown due to over current	Mains Supply Current is too high	Have an Accredited ESAB Service Provider check the power source
E19 -00	HF Ignition Faulty	HF Ignition Faulty	Have an Accredited ESAB Service Provider check the power source
E22 -00	Mains Supply Under Voltage	Mains Supply Voltage is too low	Check Mains Supply Voltage

	The Electrode is shorted to work piece when machine is turned ON	VRD defective, or short circuit between torch and work piece	Switch OFF and ON the power source to clear the error code
	Configuration Error	Defective PCB, incorrect system software	Have an Accredited ESAB Service Provider check the power source
	Control Panel identification	Control Panel identification error	Have an Accredited ESAB Service Provider check the power source
	Power Module	Power Module not symmetrical	Have an Accredited ESAB Service Provider check the power source

Table 5-2: Error Message

5.02 Power Source Problems

FAULT	CAUSE	REMEDY
1 Mains supply voltage is ON, Control panel LED's are illuminated however unit will not commence welding when the torch trigger switch is depressed.	A Power source is not in the correct mode of operation. B Faulty torch trigger.	A Set the power source to the correct mode of operation with the process selection switch. Repair or replace torch trigger switch/lead. B
2 Mains supply voltage is ON. Indicator light is not lit and welding arc cannot be established.	A Primary control fuse is blown. Broken connection in primary circuit. B	A Replace primary control fuse. B Have an Accredited ESAB Service Provider check primary circuit.
3 Error Code E01 is displayed and unit will not commence welding when the torch trigger switch is depressed.	Duty cycle of power source has been exceeded.	Leave the power source switched ON and allow it to cool. Note that fault indicator must be extinguished prior to commencement of welding.
4 Welding output continues when torch trigger released	A Trigger mode selection is in 4T (LATCH) mode B Torch trigger leads shorted	A Change to 2T (NORMAL) mode B Repair or replace Torch / trigger lead
5 Welding output voltage is present when the torch trigger switch is depressed but arc cannot be established.	Poor or no work lead contact.	Clean work clamp area and ensure good electrical contact.
6 Welding output voltage is not present when torch trigger depressed	Faulty trigger switch / lead	Repair or replace Torch / trigger lead
7 TIG electrode melts when arc is struck.	TIG torch is connected to the Worklead terminal.	Connect the TIG torch to the Electrode terminal.
8 Arc flutters during TIG welding.	Tungsten electrode is too large for the welding current.	Select the correct size of tungsten electrode.
9 No HF output in HF mode	HF Circuit faulty	Have an Accredited ESAB Service Provider check HF circuit.
10 Error Code is displayed	Refer to the error code list, section 3.16	Refer to the error code list, section 3.16

Table 5-3: Power Source Problem

5.03 Routine Service and Calibration Requirements



WARNING

There are extremely dangerous voltage and power levels present inside this Inverter Power Source. Do not attempt to open or repair unless you are an accredited ESAB Service Provider. Disconnect the Welding Power Source from the Mains Supply Voltage before disassembling.

Routine Inspection, Testing & Maintenance

The inspection and testing of the power source and associated accessories shall be carried out by a licensed electrician. Safety in Welding and Allied Processes-Part 2 Electrical. This includes an insulation resistance test and an earthing test to ensure the integrity of the unit is compliant with ESAB original specifications.

A. Testing Schedule

1. For transportable equipment, at least once every 3 months; and
2. For fixed equipment, at least once every 12 months.

The owners of the equipment shall keep a suitable record of the periodic tests and a system of tagging, including the date of the most recent inspection.

A transportable power source is deemed to be any equipment that is not permanently connected and fixed in the position in which it is operated.

B. Insulation Resistance

Minimum insulation resistance for in-service ESAB Inverter Power Sources shall be measured at a voltage of 500V between the parts referred to in Table 5-2 below. Power sources that do not meet the insulation resistance requirements set out below shall be withdrawn from service and not returned until repairs have been performed such that the requirements outlined below are met.

Components to be Tested	Minimum Insulation Resistance (M Ω)
Input circuit (including any connected control circuits) to welding circuit (including any connected control circuits)	5
All circuits to exposed conductive parts	2.5
Welding circuit (including any connected control circuits) to any auxiliary circuit which operates at a voltage exceeding extra low voltage	10
Welding circuit (including any connected control circuits) to any auxiliary circuit which operates at a voltage not exceeding extra low voltage	1
Separate welding circuit to separate welding circuit	1

Table 5-4: Minimum Insulation Resistance Requirements: ESAB Inverter Power Sources

C. Earth Grounding

The resistance shall not exceed 1 Ω between any metal of a power source where such metal is required to be Earth Ground, and -

1. The Earth Ground terminal of a fixed power source; or
2. The Earth Ground terminal of the associated plug of a transportable power source

Note that due to the dangers of stray output currents damaging fixed wiring, the integrity of fixed wiring supplying ESAB welding power sources should be inspected by a licensed electrical worker in accordance with the requirements below -

1. For outlets/wiring and associated accessories supplying transportable equipment - at least once every 3 months; and
2. For outlets/wiring and associated accessories supplying fixed equipment - at least once every 12 months.

D. General Maintenance Checks

Welding equipment should be regularly checked by an accredited ESAB Service Provider to ensure that:

1. Flexible cord is of the multi-core tough rubber or plastic sheathed type of adequate rating, correctly connected and in good condition.
2. Welding terminals are in suitable condition and are shrouded to prevent inadvertent contact or short circuit.
3. The Welding System is clean internally, especially from metal filing, slag, and loose material.

E. Accessories

Accessory equipment, including output leads, electrode holders, torches, wire feeders and the like shall be inspected at least monthly by a competent person to ensure that the equipment is in a safe and serviceable condition. All unsafe accessories shall not be used.

F. Repairs

If any parts are damaged for any reason, it is recommended that replacement be performed by an accredited ESAB Service Provider.

Power Source Calibration**A. Schedule**

Output testing of all ESAB Inverter Power Sources and applicable accessories shall be conducted at regular intervals to ensure they fall within specified levels. Calibration intervals shall be as outlined below -

1. For transportable equipment, at least once every 3 months; and
2. For fixed equipment, at least once every 12 months.

If equipment is to be used in a hazardous location or environments with a high risk of electrocution as outlined in EN 60974-1, then the above tests should be carried out prior to entering this location.

B. Calibration Requirements

Where applicable, the tests outlined in Table 5-3 below shall be conducted by an accredited ESAB service provider.

Testing Requirements
Output current (A) to be checked to ensure it falls within applicable ESAB power source specifications
Output Voltage (V) to be checked to ensure it falls within applicable ESAB power source specifications
Accuracy of digital meters to be checked to ensure it falls within applicable ESAB power source specifications

Table 5-5: Calibration Parameters

Periodic calibration of other parameters such as timing functions are not required unless a specific fault has been identified.

C. Calibration Equipment

All equipment used for Power Source calibration shall be in proper working condition and be suitable for conducting the measurement in question. Only test equipment with valid calibration certificates (NATA certified laboratories) shall be utilized.

5.04 Cleaning the Welding Power Source**WARNING**

There are dangerous voltage and power levels present inside this product. Do not attempt to open or repair unless you are a qualified electrical tradesperson. Disconnect the Welding Power Source from the Mains Supply Voltage before disassembling.

To clean the Welding Power Source, open the enclosure and use a vacuum cleaner to remove any accumulated dirt, metal filings, slag and loose material. Keep the shunt and lead screw surfaces clean as accumulated foreign material may reduce the welders output welding current.

This Page Intentionally Blank

SECTION 6: KEY SPARE PARTS

This Page Intentionally Blank.
See next two pages.

ET 2011 AC/DC

6.01 Key Spare Parts

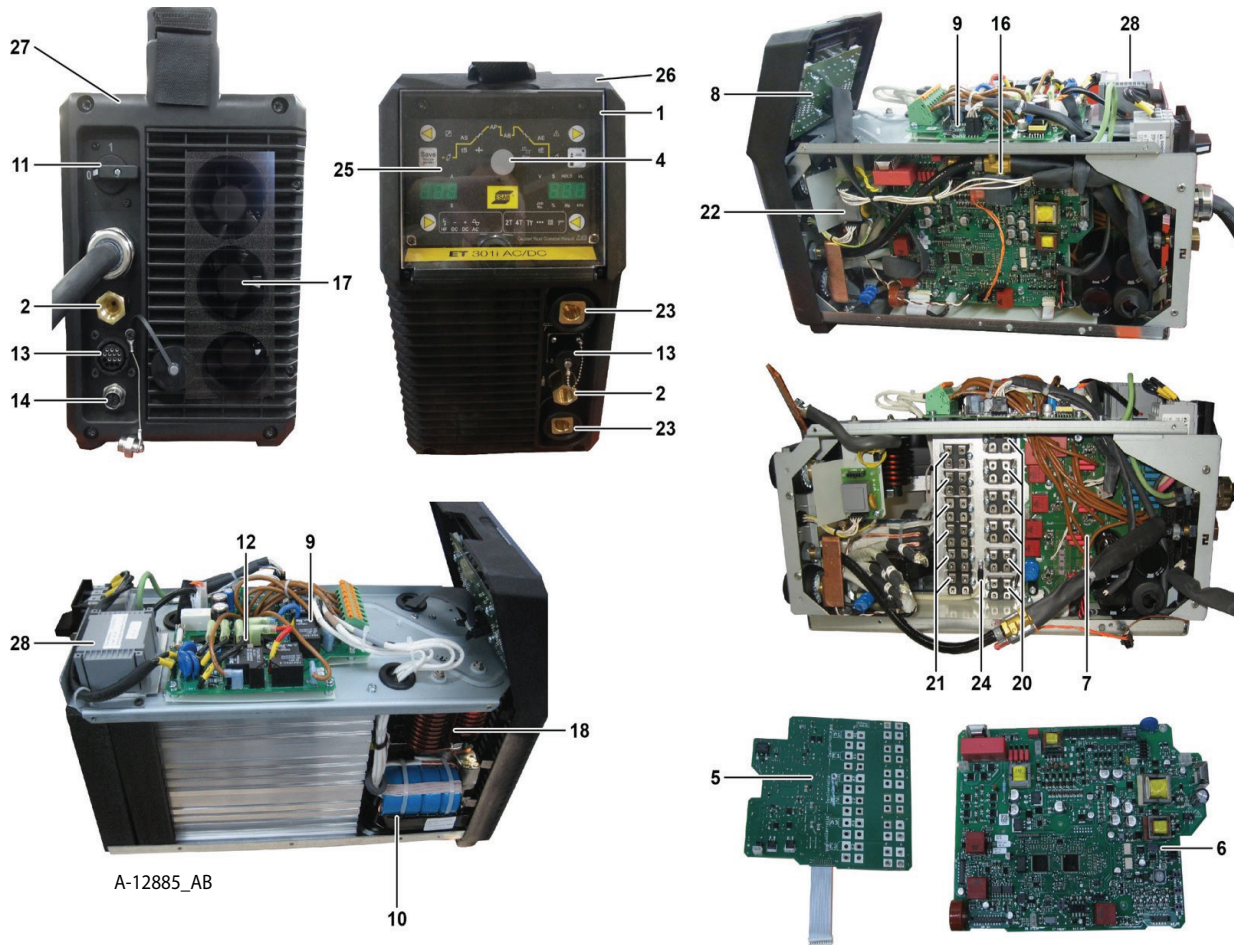

Figure 6-1: Spare Parts

ET 220i AC/DC Spare Parts		
Item	Part Number	Description
1	W7006300	Clear Control Panel Cover
2	W7006301	Gas Outlet, Front Panel
2	W7006301	Gas Inlet, Rear Panel
4	W7006500	Knob, Control
5	W7006323	PCB Secondary Rectifier
6	W7006433	PCB Control
7	W7006434	PCB Primary Inverter
8	W7006307	PCB, Display
9	W7006427	REL02
10	W7006326	Transformer, Inverter
11	W7006439	Switch, On/Off
12	W7006426	Rectifier, Bridge, Mains Supply
13	W7006314	Cable Assy, 8 Pin Remote
14	W7006431	Cable Assy, 4 Pin CAN
13	667.8377.0	Cable Assy, 14 Pin Remote
16	W7006315	Solenoid 24VDC
17	W7006316	Fan 12VDC
18	W7006317	Inductor HF
20	W7006319	IGBT
21	W7006740	Diode, Output
22	W7006425	HF Filter
23	W7006430	Panel Mount Dinse Socket 50mm ²
24	W6000000	Thermal Sensor
25	W7006441	Panel, Control (User Interface)
26	W7006429.	Panel, Front
27	W7006440	Panel, Rear
28	W7006428	Transformer, Control

Table 6-1: Spare Parts

This Page Intentionally Blank

APPENDIX A: CIRCUIT DIAGRAM OF ET 220i AC/DC

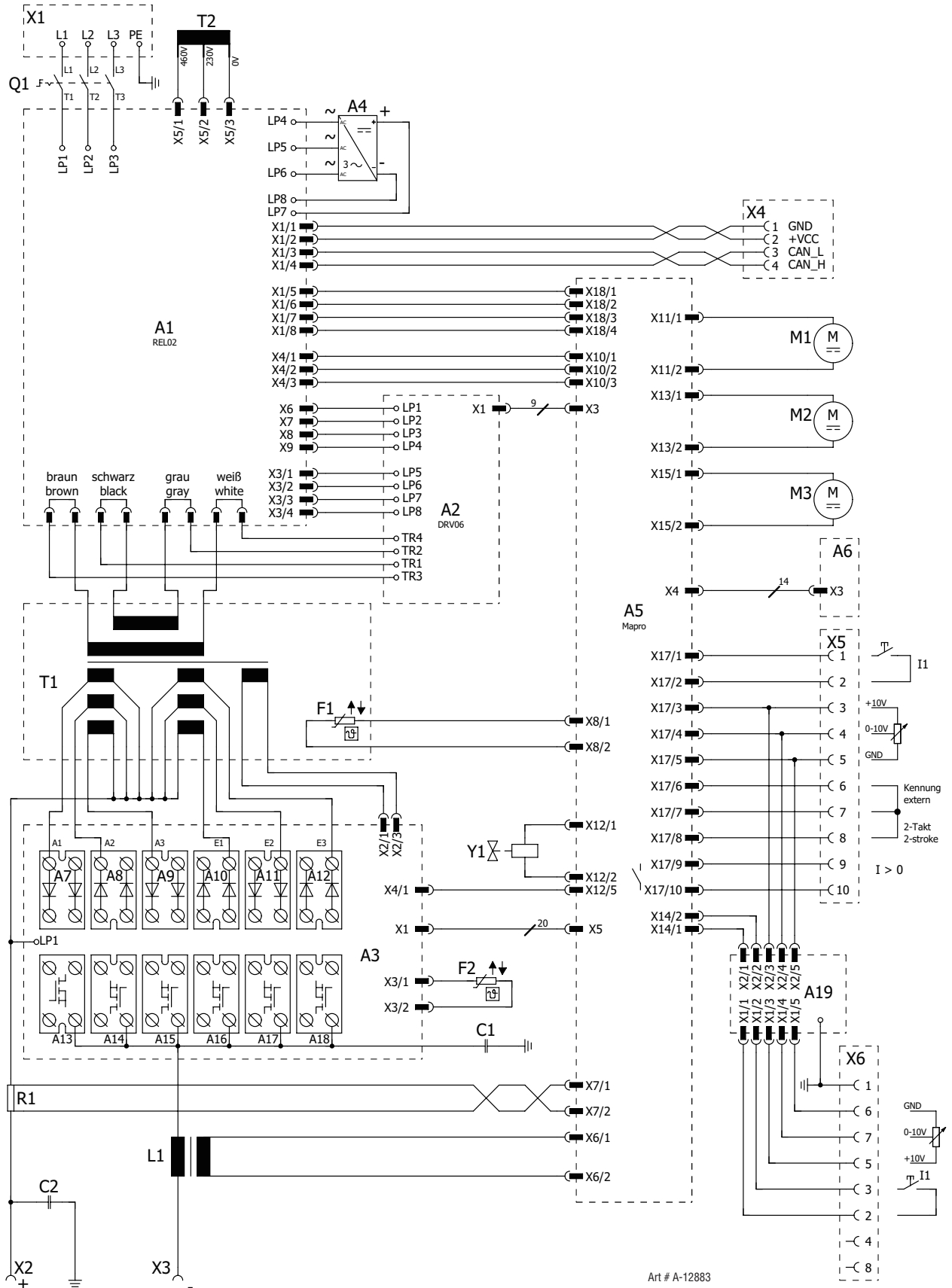

Art # A-12883

REVISION HISTORY

<u>Cover Date</u>	<u>Rev.</u>	<u>Change(s)</u>
05/07/15	AA	Manual release
01/15/16	AB	Updated 'Liftarc TIG' wording, Section 6 art, spart parts list and Appendix art.

ESAB subsidiaries and representative offices

Europe

AUSTRIA

ESAB Ges.m.b.H
Vienna-Liesing
Tel: +43 1 888 25 11
Fax: +43 1 888 25 11 85

BELGIUM

S.A. ESAB N.V.
Heist-op-den-Berg
Tel: +32 70 233 075
Fax: +32 15 257 944

BULGARIA

ESAB Kft Representative Office
Sofia
Tel/Fax: +359 2 974 42 88

THE CZECH REPUBLIC

ESAB VAMBERK s.r.o.
Vamberk
Tel: +420 2 819 40 885
Fax: +420 2 819 40 120

DENMARK

Aktieselskabet ESAB
Herlev
Tel: +45 36 30 01 11
Fax: +45 36 30 40 03

FINLAND

ESAB Oy
Helsinki
Tel: +358 9 547 761
Fax: +358 9 547 77 71

FRANCE

ESAB France S.A.
Cergy Pontoise
Tel: +33 1 30 75 55 00
Fax: +33 1 30 75 55 24

GERMANY

ESAB GmbH
Solingen
Tel: +49 212 298 0
Fax: +49 212 298 218

GREAT BRITAIN

ESAB Group (UK) Ltd
Waltham Cross
Tel: +44 1992 76 85 15
Fax: +44 1992 71 58 03
ESAB Automation Ltd
Andover
Tel: +44 1264 33 22 33
Fax: +44 1264 33 20 74

HUNGARY

ESAB Kft
Budapest
Tel: +36 1 20 44 182
Fax: +36 1 20 44 186

ITALY

ESAB Saldatura S.p.A.
Bareggio (Mi)
Tel: +39 02 97 96 8.1
Fax: +39 02 97 96 87 01

THE NETHERLANDS

ESAB Nederland B.V.
Amersfoort
Tel: +31 33 422 35 55
Fax: +31 33 422 35 44

NORWAY

AS ESAB
Larvik
Tel: +47 33 12 10 00
Fax: +47 33 11 52 03

POLAND

ESAB Sp.zo.o.
Katowice
Tel: +48 32 351 11 00
Fax: +48 32 351 11 20

PORTUGAL

ESAB Lda
Lisbon
Tel: +351 8 310 960
Fax: +351 1 859 1277

ROMANIA

ESAB Romania Trading SRL
Bucharest
Tel: +40 316 900 600
Fax: +40 316 900 601

RUSSIA

LLC ESAB
Moscow
Tel: +7 (495) 663 20 08
Fax: +7 (495) 663 20 09

SLOVAKIA

ESAB Slovakia s.r.o.
Bratislava
Tel: +421 7 44 88 24 26
Fax: +421 7 44 88 87 41

SPAIN

ESAB Ibérica S.A.
Alcalá de Henares (MADRID)
Tel: +34 91 878 3600
Fax: +34 91 802 3461

SWEDEN

ESAB Sverige AB
Gothenburg
Tel: +46 31 50 95 00
Fax: +46 31 50 92 22
ESAB international AB
Gothenburg
Tel: +46 31 50 90 00
Fax: +46 31 50 93 60

SWITZERLAND

ESAB AG
Dietikon
Tel: +41 1 741 25 25
Fax: +41 1 740 30 55

UKRAINE

ESAB Ukraine LLC
Kiev
Tel: +38 (044) 501 23 24
Fax: +38 (044) 575 21 88

North and South America

ARGENTINA

CONARCO
Buenos Aires
Tel: +54 11 4 753 4039
Fax: +54 11 4 753 6313

BRAZIL

ESAB S.A.
Contagem-MG
Tel: +55 31 2191 4333
Fax: +55 31 2191 4440

CANADA

ESAB Group Canada Inc.
Mississauga, Ontario
Tel: +1 905 670 02 20
Fax: +1 905 670 48 79

MEXICO

ESAB Mexico S.A.
Monterrey
Tel: +52 8 350 5959
Fax: +52 8 350 7554

USA

ESAB Welding & Cutting Products
Florence, SC
Tel: +1 843 669 44 11
Fax: +1 843 664 57 48

Asia/Pacific

AUSTRALIA

ESAB South Pacific
Archerfield BC QLD 4108
Tel: +61 1300 372 228
Fax: +61 7 3711 2328

CHINA

Shanghai ESAB A/P
Shanghai
Tel: +86 21 2326 3000
Fax: +86 21 6566 6622

INDIA

ESAB India Ltd
Calcutta
Tel: +91 33 478 45 17
Fax: +91 33 468 18 80

INDONESIA

P.T. ESABindo Pratama
Jakarta
Tel: +62 21 460 0188
Fax: +62 21 461 2929

JAPAN

ESAB Japan
Tokyo
Tel: +81 45 670 7073
Fax: +81 45 670 7001

MALAYSIA

ESAB (Malaysia) Snd Bhd
USJ
Tel: +603 8023 7835
Fax: +603 8023 0225

SINGAPORE

ESAB Asia/Pacific Pte Ltd
Singapore
Tel: +65 6861 43 22
Fax: +65 6861 31 95

SOUTH KOREA

ESAB SeAH Corporation
Kyungnam
Tel: +82 55 269 8170
Fax: +82 55 289 8864

UNITED ARAB EMIRATES

ESAB Middle East FZE
Dubai
Tel: +971 4 887 21 11
Fax: +971 4 887 22 63

Africa

EGYPT

ESAB Egypt
Dokki-Cairo
Tel: +20 2 390 96 69
Fax: +20 2 393 32 13

SOUTH AFRICA

ESAB Africa Welding & Cutting Ltd
Durbanvill 7570 - Cape Town
Tel: +27 (0)21 975 8924

Distributors

For addresses and phone numbers
to our distributors in other coun-
tries, please visit our home page
www.esab.eu



www.esab.com