

Big Blue® 400 Pro

**Diesel Engine-Driven
Welder/AC Generator** 

Quick Specs



Heavy Industrial Applications

Mechanical contractors
Structural steelwork
Fabrication
Maintenance
Repair
Rental
Construction
Pipe welding

Processes

Stick (SMAW)
MIG (GMAW)*
Flux-cored (FCAW)*
RMD®**
Pulsed MIG (GMAW-P)**
DC TIG (GTAW)
Air carbon arc (CAC-A)
Rated: 3/16-inch (4.8 mm) carbons
Capable: 1/4-inch (6.4 mm) carbons

Output Range DC stick 20–400 A
MIG/flux-cored 14–40 V
DC TIG 20–400 A

Generator Output Rated at 104°F (40°C)
12,000 watts peak, 10,000 watts continuous

**Accu-Rated™ – Not Inflated
Generator Power**

*With wire feeder.

**ArcReach models only with ArcReach Smart Feeder.

The professional welder's choice —

designed with the professional in mind, the Big Blue 400 Pro is the best for ease of use, reliability and fuel economy.

Heavy-duty low-speed T4F and T4i industrial diesel engines designed to operate over 10,000 hours before the first basic overhaul. Backed by worldwide support and service.



Kubota V1505 four-cylinder diesel.



Mitsubishi S4L2 four-cylinder diesel.



CATERPILLAR C1.5 three-cylinder diesel and C1.5T turbo-charged three-cylinder diesel.



Optimized arc control for stick welding applications. See page 2.



Parameter control at the wire feeder or pendant without needing a control cord. See page 2.



WIRELESS INTERFACE CONTROL



NEW!

Full control of your machine in the palm of your hand. See page 3.



Durable and built to last in harsh industrial environments.



Superior arc performance.



International models available.

USA model shown is



Welder/generator is warranted for three years, parts and labor.
Engine is warranted separately by engine manufacturer.



Miller Electric Mfg. LLC
An ITW Welding Company
1635 West Spencer Street
P.O. Box 1079
Appleton, WI 54912-1079 USA

Equipment Sales US and Canada
Phone: 866-931-9730
FAX: 800-637-2315
International Phone: 920-735-4554
International FAX: 920-735-4125

MillerWelds.com



Big Blue® 400 Pro Features and Controls

Digital meters with SunVision™ technology enable welding parameters to be viewed with greater clarity than analog meters — at virtually any angle. Meters can be seen clearly even in direct sunlight.

Meters display

- Process settings for quick and easy setup
- Preset and actual amperage

Simple-to-set controls

require no elaborate procedure — just select process and weld.

10,000 watts of pure generator power.

Plug in an extra Miller® inverter-based power source for a second welding arc.

Industrial USB port.

Quickly upload the latest software and download machine log files.



**56.7°C
RATED**

Miller engine drives are tested to perform in high-temperature climates, even at the highest recorded temperature on earth — 56.7°C*. They are designed to excel in extreme heat by optimizing engine cooling, reducing harmful environmental effects.

*According to the World Meteorological Organization Global Weather & Climate Extremes Archive (<https://wmo.asu.edu/content/world-highest-temperature>)



Arc control is beneficial when welding with stick and solid wires for easier fine-tuning of tough-to-weld materials and out-of-position applications.

Standard 14-pin receptacle with Auto-Remote Sense™ for simple connection of remote controls and wire feeders.

Thermal overload protection prevents machine damage if the duty cycle is exceeded or airflow is blocked.

Low OCV stick (VRD), when enabled, reduces the open-circuit voltage to 30 volts when the welding power source is not in use, increasing operator safety without compromising arc starts.

HD powder coat with zinc-rich primer protects sheet metal from rust and corrosion.

Standard features include adjustable Hot Start™, output contactor control, automatic idle, 120-volt block heater and Dynamic DIG™.

Big Blue® 400 Pro Technologies

Dynamic DIG™ technology



Ultra-adaptive arc control. Unlike conventional DIG that provides a preset amount of short-clearing current, Miller-exclusive Dynamic DIG technology works on a time-based algorithm that automatically

adjusts the amount of current required to clear a short. Delivers a smoother more consistent arc that can be tailored to match application, material, fit-up and welder technique.

ArcReach® technology (option)

ArcReach Parameter control at the wire feeder or pendant without needing a control cord.

An ArcReach system allows you to change weld settings from your ArcReach feeder or stick/TIG remote, saving a trip to the power supply. ArcReach technology uses the existing weld cable to communicate welding control information between the feeder or stick/TIG remote and the power source. This technology eliminates the need for control cords, and their associated problems and costs.

ArcReach-equipped power sources work with non-ArcReach accessories; however the ArcReach benefit is only realized with the complete ArcReach system. This includes an ArcReach-equipped machine and one or more of the following accessories:

- ArcReach SuitCase feeder
- ArcReach Smart Feeder
- ArcReach Stick/TIG Remote

See pages 6 and 7 for more information.

Big Blue® 400 Pro Technologies

Wireless interface control (option)

WIRELESS INTERFACE CONTROL

Work hassle-free with full welder/generator control in the palm of your hand.

With wireless interface control, you can remotely switch between welding processes, adjust parameters, select and save preset programs, turn the machine on/off, get service reminders and more from wherever you are on the jobsite — for a more productive day.

Maximize fuel savings and reduce unnecessary engine hours when you use wireless interface control to instantly turn your machine off when needed.

Extend time between fill ups and maintenance intervals while eliminating the need to go back to your machine or climb into the truck to make adjustments.

Wireless interface control is a factory-installed option available on the Big Blue 400 Pro.

VIEW STATUS

View engine status, fuel level, and battery charge level of remote.

SELECT PROCESSES

View and select between all available processes.

CONTACTOR ON/OFF

Turn contactor on/off manually in remote welding mode.

ENGINE ON/OFF

Turn engine on/off with remote.



CUSTOM PROGRAMS

Save custom presets in up to four programs and easily switch between pre-programmed settings.

FINE-TUNE ARC

Quickly adjust and save arc control settings including DIG, DIG range inductance and Auto-Stop.

AMP/VOLT ADJUST

Adjust amperage or voltage, by increments or percentage, while welding.

Big Blue® 400 Pro Benefits

Easily update technology



With the industrial USB port, you can easily upload the latest software and download machine log files to retrieve in-depth information from your machine such as diagnostics and statistics.

Visit MillerWelds.com/support to download the latest software updates.

Less noise



Quieter jobsites are more productive because work crews can communicate easier. The Big Blue 400 Pro is only 71.6 decibels (96 Lwa) under a full load, allowing

for easier jobsite communication. Optional wireless interface control makes it easier to shut off your machine when it's not in use, so you can lower jobsite noise levels and hear what's going on around you.

Jobsite safety



Reduce the need to walk back to or climb into the truck bed to make process and parameter changes, or turn your machine on/off. ArcReach® technology provides

parameter control at the wire feeder or stick/TIG remote and optional wireless interface control provides full front panel control in the palm of your hand, so you can lower the risk of encountering potential jobsite hazards.

Specifications (Subject to change without notice.)



Weld Mode/ Process	Weld Output Range	Weld Output Rated at 100% Duty Cycle at 104°F (40°C)	Max. Open-Circuit Voltage	Generator Power Output Rated at 104°F (40°C)**	Sound Levels at Rated Output, 23 ft. (7 m)	Dimensions	Net Weight (without fuel)***
CC/DC (TIG)	20–400 A	300 A at 32 VDC 350 A at 27 VDC 400 A at 24 VDC	85 VDC 30 VDC*	12,000 watts peak, 10,000 watts continuous 1-phase, 84/42 A, 120/240 VAC, 60 Hz	Mitsubishi Idle: 68.7 dB (93 Lwa) Weld: 72.1 dB (97 Lwa) Kubota Idle: 66 dB (91 Lwa) Weld: 71.6 dB (96 Lwa) CAT Idle: 65 dB (90 Lwa) Weld: 71.2 dB (96 Lwa)	H: 32 in. (813 mm) W: 26.25 in. (667 mm) D: 56 in. (1,422 mm)	Mitsubishi 993 lb. (450 kg) Kubota 950 lb. (431 kg) CAT 1,010 lb. (458 kg)
CC/DC (Stick)	20–400 A						
CV/DC (FCAW/MIG)	14–40 V						

*Sense voltage for Lift-Arc™ TIG and stick with VRD on.

**Will operate either 60 Hz or 50/60 Hz power tools, lights, etc.

***Additional 82 lb. (37 kg) when fuel tank is full.

Certified by Canadian Standards Association to both the Canadian and U.S. Standards. Meets NEMA and IEC output ratings.

Engine Specifications (Engines warrantied separately by the engine manufacturer.)

Engine Brand	Features	HP	Type	Engine Speeds	Capacities	Automatic Engine Shutdown
Mitsubishi S4L2	EPA Tier 4 Final compliant, includes 120 V block heater	24.7	Four-cylinder, liquid-cooled industrial diesel	Idle: 1,500 rpm Weld: 1,800 rpm	Fuel: 11.5 gal. (43.5 L) Oil: 6 qt. (5.7 L) Coolant: 6 qt. (5.7 L)	Low oil pressure, high coolant temperature, low fuel level
Kubota V1505		20.2	Four-cylinder, liquid-cooled industrial diesel			
Caterpillar C1.5T		24.7	Turbo-charged three-cylinder, liquid-cooled industrial diesel		Fuel: 11.5 gal. (43.5 L) Oil: 5.9 qt. (5.6 L) Coolant: 6 qt. (5.7 L)	
Caterpillar C1.5	EPA Tier 4i compliant, includes 120 V block heater	21.7	Three-cylinder, liquid-cooled industrial diesel			

Performance Data

Fuel Consumption Curve

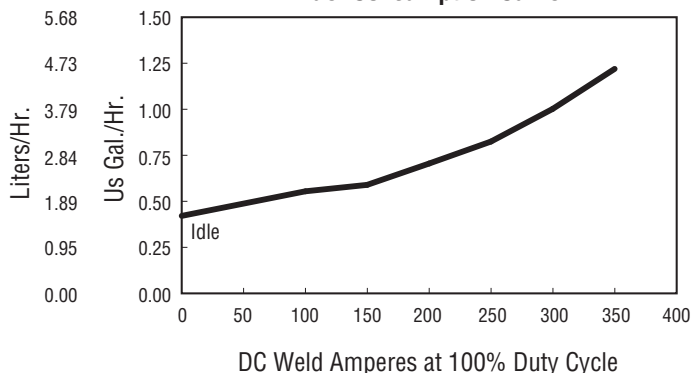

Simultaneous Welding and Power

Weld Amperes	Total Aux. Power Available (Watts)
25 A	10,000
75 A	10,000
125 A	10,000
175 A	9,000
225 A	7,500
300 A	4,500
350 A	1,000

Function Guide

1. **Self-calibrating digital weld meters with fault code indication** display preset or actual weld parameters.
2. **Pushbutton main control knob** used for adjusting amperage/voltage, adjusting arc control, and accessing the service menu.
3. **LED process indicator.** Front panel process selections are illuminated with an LED that identifies the active process. This enables the selected weld process to be seen at a distance from the power source.

4. Lift-Arc™ TIG with Auto-Stop™ and Auto-Crater™

5. **USB port** allows software updates from a USB drive. A summary file of recorded data from the unit will be saved to a USB drive that is inserted.
6. **Weatherproof Lexan® nameplate** is super durable and resists cracking and fading.
7. **Adjustable arc control** adjusts DIG when process control is in stick mode and adjusts inductance when process control is in FCAW or MIG mode. The amount of DIG determines how much amperage (heat) varies with stick arc length. Inductance determines the “wetness” of the weld puddle.

8. **Maintenance interval reminder.** Yellow and red indicator lights let an operator know when the machine is approaching and finally in need of routine maintenance.
9. **Fuel indicator gauge.** Low fuel shutdown shuts engine off prior to running out of fuel to prevent loss of fuel in the system, and make restarts easy.
10. **Glow plugs** assist in cold weather starting.
11. **Engine control switch** is used to start the engine and then select between auto idle and high speed lock.

12. **Standard 14-pin receptacle** for simple connection of remote controls and wire feeders. Includes **Auto Remote Sense™** which automatically switches from panel to remote amperage/voltage (A/V) control with remote connected. Eliminates confusion of a panel/remote switch.

13. **50 A, 120/240 V receptacle and 20 A, 120 V GFCI receptacles with circuit breakers**
Note: For matching 240 V plug, order 119172.

14. **Weld output terminals**

15. **International receptacle panel with 16 A, 240 V receptacle, 20 A 120 V GFCI receptacle and 32 A, 240 V receptacle with circuit breakers**

Note: For matching 240 V, 16 A plug, order 255416 and for matching 240 V, 32 A plug, order 255418.

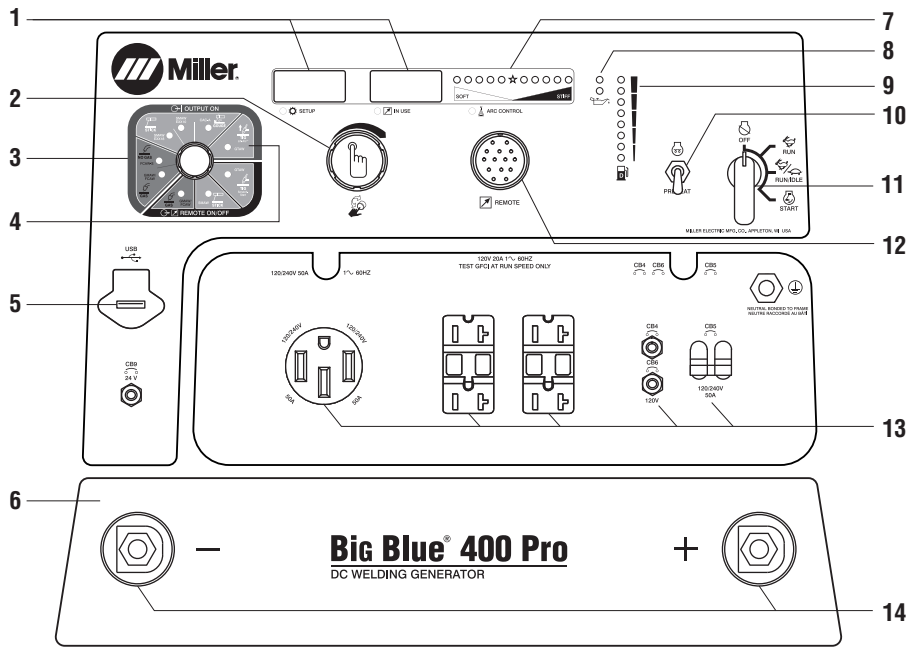

USA Model

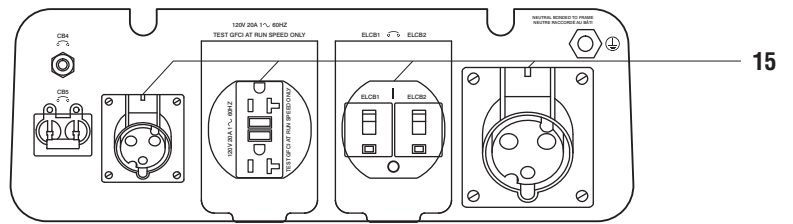

International Model Receptacles

ARC START with Lift-Arc™

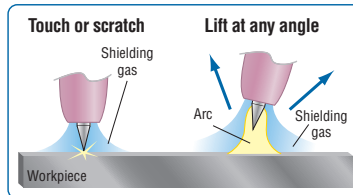

- Reduces or eliminates sticking
- Reduces or eliminates electrode/work contamination
- Low open-circuit voltage

ARC END with Auto-Stop™

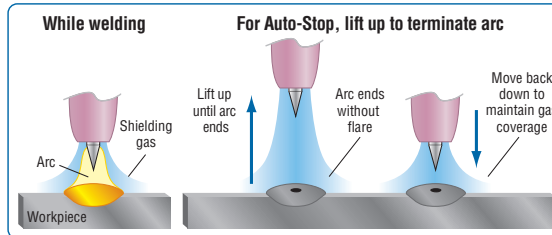

- Eliminates need for a remote control
- Maintains shielding gas coverage
- Eliminates tungsten and workpiece contamination
- Eliminates unwanted arc strikes outside the weld area

ARC END with Auto-Crater™

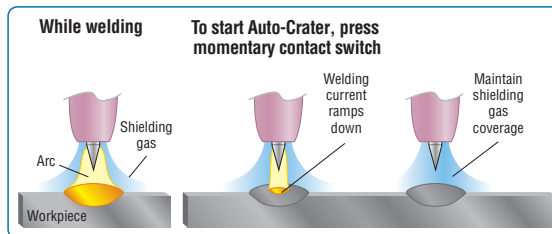

- Maintains shielding gas coverage
- Eliminates tungsten and workpiece contamination
- Auto-Crater time allows for addition of filler
- Eliminates unwanted arc strikes outside the weld area

Genuine Miller® Accessories

Wireless Interface Control Protective Covers

287594 Field

Five-pack of screen protectors for wireless interface control remote.



Female Receptacle



Full KVA Adapter Cord 300517 Field
NEMA 14-50P to NEMA 6-50R. Adapts engine drive 120/240 V plug to common Millermatic® and Spectrum® 240 V plug.



Full KVA Plug Kit 119172 Field
120/240 V, 50 A plug (NEMA 14-50P) to fit full KVA receptacle.



International Plug 255416 Field
1-phase, 240 V, 16 A plug

Engine Filter Kits Field

252782 For Mitsubishi (USA)

253901 For Kubota (USA/Int'l)

274427 For CAT Turbo (USA/Int'l)

246987 For CAT (Int'l)

Includes all filters required for proper engine maintenance. Oil filter, primary and secondary fuel filter, and primary air filter.



Spark Arrestor (Muffler) Kit 300585 Field
Prevents particles from leaving the muffler that could potentially start a

fire. Mandatory when operating on California grasslands, brush, or forest-covered land, and in all national forests. For other areas, check your state and local laws. Meets U.S. Forest Service Standard 5100-1B.



FA-1D Lockable Flame Arrestor Fuel Cap 043947 Field
Fuel cap can be padlocked to prevent vandalism. A built-in flame arrestor prevents flames or sparks from entering the fuel tank.

Remote Output Panel Kit 951850 Field
If your welder/generator is mounted on a truck, easily locate the outputs at the point of use with the auxiliary power and weld output remote panel. See literature AY/20.5.



Protective Cover 195301 Field
Blue water-resistant cover with Miller logo resists stains and mildew, and protects the finish of your welder.

MIG/Flux-cored Welding



ArcReach® SuitCase® 8 951726 With Bernard® BTB Gun 300 A
951727 With Bernard® S-Gun™
951728 With Bernard® Dura-Flux™ gun

ArcReach® SuitCase® 12 951729 With Bernard® BTB Gun 300 A
951730 With Bernard® S-Gun™
951731 With Bernard® Dura-Flux™ gun

ArcReach® SuitCase® 12 Heavy Duty 301604 Feeder only — for 3/32-inch cored wire
Portable feeder designed to run off of arc voltage. When paired with an ArcReach power source, provides remote control of the power source without a control cord — saving time and money. See literature M/6.55.



ArcReach® Smart Feeder 951733
For use with ArcReach models only (see page 3 for more information). Includes drive rolls and Bernard® PipeWorx 300-15 MIG gun. For MIG, FCAW, and advanced RMD® and pulse processes. See literature M/6.55.



SuitCase® 12RC

Wire Feeder 951580

Lightweight and flexible enough to run wires up to .062-inch diameter. Includes remote voltage control, drive roll kit and Bernard® BTB Gun 300 A. See literature M/6.5.

MIG (GMAW)/Flux-cored (FCAW) Guns

See Bernard® literature SP-BTB for BTB air-cooled MIG guns, and SP-DF for Dura-Flux™ self-shielded flux-cored guns.



Spoolmatic® 30A Spool Gun 130831

Air-cooled, 200-amp, one-pound spool gun for aluminum and stainless MIG. See literature M/1.73. Requires WC-24 Control **137549**.

XR™ Wire Feeders and Guns

Push-pull system designed to handle difficult-to-feed soft alloy wires such as aluminum. See literature M/1.7 through M/1.74.

AC TIG (GTAW) Welding

The Dynasty 210 power sources can be run off the engine drive's generator to provide two arcs with only one engine.



Dynasty® 210 Series

For portable AC/DC TIG. See literature AD/4.81.

Multiple Operator Welding

The XMT 350 FieldPro and CST 280 power sources can be run off the engine drive's generator to provide two arcs with only one engine.



XMT® 350 FieldPro™
See literature DC/18.96.



CST™ 282
See literature DC/29.6.

Genuine Miller® Accessories (Continued)

Plasma Cutting



Spectrum 375 X-TREME and 625 X-TREME shown.

Spectrum® 375 X-TREME™ 907529

See literature PC/9.2.

Spectrum® 625 X-TREME™ 907579

See literature PC/9.6.

Spectrum® 875 907583

See literature PC/9.8.

The Spectrum 375 X-TREME and 625 X-TREME come complete with protective X-CASE™ (not shown).

Stick/TIG Remote Controls



ArcReach® Stick/TIG Remote 301325

When paired with an ArcReach power source, provides remote control of the power source without a control cord — saving time

and money. See literature AY/14.5.



RHC-14 Hand Control 242211020

Miniature hand control for remote current, voltage and contactor control. Dimensions:

4 x 4 x 3.25 in. (102 x 102 x 82 mm).

Includes 20-foot (6 m) cord and 14-pin plug.



Wireless Remote Hand Control 301582

For remote current, voltage and contactor control.

Receiver plugs directly into the 14-pin receptacle of Miller machine. Up to 300-foot (91.4 m) operating range.

Wireless antenna kit **300749** is recommended.

Wireless Antenna Kit 300749

Recommended for improved reception.



RMS-14 On/Off Control 187208

Momentary-contact switch for contactor control. Rubber-covered pushbutton dome switch ideal for repetitive on-off applications. Includes 26.5-foot (8 m) cord and 14-pin plug.



RCC-14 Remote Contactor and Current Control 151086

East/west rotary-motion fingertip control attaches to TIG torch using two hook-and-loop fasteners. Includes 26.5-foot (8 m) cord and 14-pin plug.

PRHC-14 Hand Control 195511

Complete current or voltage control brings 120 volts GFCI power to work area in a single cord. Housed in a durable, light aluminum case and includes 125-foot (38 m) cord with plugs.

Extension Cables for 14-Pin Remote Controls or 24 VAC Wire Feeders

242208025 25 ft. (7.6 m)

242208050 50 ft. (15.2 m)

242208080 80 ft. (24.4 m)

Trailers and Hitches (Note: Trailers are shipped unassembled.)



HWY-Mid Frame Trailer 301438

1,424-pound (646 kg) capacity highway trailer with welded steel tubing frame, heavy-duty axle with roller bearing hubs and leaf-spring suspension. Includes jack stand, fenders, lights, and dual hitch with 2-inch (50 mm) ball hitch and 3-inch (76 mm) lunette eye.

Cable Tree 043826

Provides an area to conveniently wrap weld cables and extension cords.



Dual Hitch 301441

Combination 2-inch (50 mm) ball hitch and 3-inch (76 mm) lunette eye in one reversible assembly.



2-In-1 Document/Fire Extinguisher Holder 301236

Stores documents and holds a 5-pound fire extinguisher.

Note: Holder shown mounted on trailer. Fire extinguisher not included.

Mounting Specifications

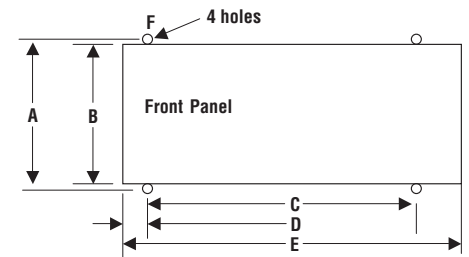

A. 27.75 in. (705 mm)

B. 26.25 in. (667 mm)

C. 52.25 in. (1,327 mm)

D. 2 in. (51 mm)

E. 56 in. (1,422 mm)

F. .562 in. (14 mm) diameter

Height: 32 in. (813 mm)

Width: 26.25 in. (667 mm)

Depth: 56 in. (1,422 mm)

Trailer Specifications (Subject to change without notice.)

Model	Gross Axle Weight Rating	Gross Vehicle Weight Rating	Net Payload	Height of Bed	Road Clearance	Track (Center to center of tires)	Standard Tires (Standard rating or P-size rating)	Dimensions	Net Weight
HWY-Mid Frame	1,605 lb. (728 kg)	1,424 lb. (646 kg)	1,424 lb. (646 kg)	19.5 in. (495 mm)	8 in. (203 mm)	46 in. (1,168 mm)	ST175/80D-13 Load Range C	Length: 101 in. (2,565 mm) Width: 55 in. (1,397 mm)*	181 lb. (82 kg)

*Width at outside of fenders.

Ordering Information

Equipment and Options	Stock No.	Description	Qty.	Price
Big Blue® 400 Pro (USA)	907732	Kubota. USA model		
	907733	Mitsubishi. USA model		
	907774	CAT (turbo charged). USA model		
Big Blue® 400 Pro with ArcReach® (USA)	907732001	Kubota. USA model		
	907733001	Mitsubishi. USA model		
	907774001	CAT (turbo charged). USA model		
Big Blue® 400 Pro with Wireless Interface Control and ArcReach® (USA)	907732013	Kubota. USA model		
	907733002	Mitsubishi. USA model		
	907774003	CAT (turbo charged). USA model		
Big Blue® 400X Pro (Int'l)	907732010	Kubota. International model		
	907732011	Kubota. International model with ArcReach®		
	907758	CAT. International model		
	907774002	CAT (turbo charged). International model		
Field Accessories				
Wireless Interface Control Protective Covers	287594	Five-pack of screen protectors for wireless interface control remote		
Full KVA Adapter Cord	300517			
Full KVA Plug Kit	119172	120/240 V		
International Plug	255416			
Engine Filter Kits		See page 6		
Spark Arrestor (Muffler) Kit	300585			
FA-1D Lockable Flame Arrestor Fuel Cap	043947			
Remote Output Panel Kit	951850	For truck mounted welder/generators. Includes auxiliary power and weld output remote panel		
Protective Cover	195301			
MIG/Flux-cored Welding				
Wire Feeders		See page 6		
MIG (GMAW) and Flux-cored (FCAW) Guns		See Bernard® literature SP-BTB and SP-DF		
Spoolmatic® 30A Spool Gun	130831	Requires WC-24 Control. See literature M/1.73		
WC-24 Control	137549	See literature M/1.73		
XR™ Wire Feeder Control and Guns		See literature M/1.7 through M/1.74		
AC TIG Welding				
		See page 6		
Multiple Operator Welding				
		See page 6		
Plasma Cutting				
		See page 7		
Stick/TIG Remote Controls				
ArcReach® Stick/TIG Remote	301325	For use with ArcReach models only		
RHC-14 Hand Control	242211020	Hand control with 20 ft. (6 m) cord		
Wireless Remote Hand Control	301582	Hand control with wireless 300 ft. (91.4 m) operating range		
Wireless Antenna Kit	300749	Recommended for improved reception		
RMS-14 On/Off Control	187208	Remote contactor control		
RCC-14 Remote Contactor and Current Control	151086	Fingertip control		
PRHC-14 Hand Control	195511	Hand control with 120 V GFCI receptacle, 125 ft. (38 m)		
Extension Cables		See page 7		
Trailers and Hitches				
HWY-Mid Frame	301438	Trailer with lights, fenders and dual hitch. For highway use		
Cable Tree	043826	Trailer-mounted cable holder		
Dual Hitch	301441	Combination 2 in. (50 mm) ball hitch and 3 in. (76 mm) lunette eye in one reversible assembly		
2-In-1 Document/Fire Extinguisher Holder	301236	Stores documents and holds a 5 lb. fire extinguisher		

Date:

Total Quoted Price:

Distributed by:

